

ΕΛΛΗΝΙΚΗ ΔΗΜΟΚΡΑΤΙΑ

ΔΗΜΟΣ ΑΧΑΡΝΩΝ

**ΠΡΑΞΗ ΕΦΑΡΜΟΓΗΣ ΤΗΣ ΠΟΛΕΟΔΟΜΙΚΗΣ
ΜΕΛΕΤΗΣ ΕΠΑ ΠΟΛΕΟΔΟΜΙΚΗΣ ΕΝΟΤΗΤΑΣ
ΑΓΙΑ ΠΑΡΑΣΚΕΥΗ ΤΟΥ ΔΗΜΟΥ ΑΧΑΡΝΩΝ**

ΤΕΥΧΟΣ ΑΕΟΝΟΔΙΑΣΤΑΥΡΩΣΕΩΝ

**ΑΝΑΔΟΧΟΙ: Χ. ΒΕΙΝΟΓΛΟΥ
Ε. ΠΑΠΑΔΑΚΗΣ**

1996

ΣΥΝΤΕΤΑΓΜΕΝΕΣ ΑΞΟΝΟΔΙΑΣΤΑΥΡΩΣΕΩΝ

A/A	X	Y	H
K 1	200390.218	456142.712	308.970
K 2	200402.513	456178.959	311.840
K 3	200406.662	456166.926	311.020
K 4	200409.789	456161.345	310.650
K 5	200414.669	456157.210	310.660
K 6	200424.719	456151.399	309.140
K 7	200409.014	456198.123	313.150
K 8	200442.960	456296.300	321.260
K 9	200501.750	456315.246	321.020
K 10	200522.981	456235.581	314.820
K 11	200537.689	456180.392	310.400
K 12	200537.826	456179.879	310.400
K 13	200578.257	456339.903	320.200
K 14	200590.947	456290.373	317.300
K 15	200665.979	456310.938	314.530
K 16	200674.604	456275.988	311.070
K 17	200635.767	456267.958	313.330
K 18	200598.569	456260.623	314.170
K 19	200598.655	456260.289	314.170
K 20	200614.020	456200.319	308.900
K 21	200614.121	456199.923	308.790
K 22	200650.059	456209.460	308.110
K 23	200757.025	456237.783	304.460
K 24	200757.526	456237.428	304.640
K 25	200733.310	456254.556	306.900
K 26	200726.968	456259.041	307.470
K 27	200707.394	456282.868	309.630
K 28	200708.616	456283.124	309.580
K 30	200690.023	456318.315	312.760
K 31	200732.020	456327.246	310.580
K 32	200739.734	456289.984	308.730
K 33	200664.014	456367.540	317.070
K 35	200744.590	456393.799	312.910
K 36	200753.044	456347.667	310.060
K 37	200788.830	456353.926	307.390
K 38	200784.114	456381.941	308.760
K 39	200755.857	456332.316	309.150
K 40	200762.652	456295.240	307.200
K 41	200794.725	456302.595	305.330
K 42	200815.546	456408.494	306.240
K 43	200823.462	456359.969	304.630
K 44	200833.024	456311.240	302.530
K 45	200838.953	456281.047	301.410
K 46	200843.109	456260.091	300.710
K 47	200940.680	456284.749	295.920
K 48	200937.263	456304.338	296.560
K 49	200932.263	456333.453	297.520
K 50	200926.829	456377.579	298.490
K 51	200922.380	456427.973	298.910
K 52	200982.138	456438.868	294.560
K 53	200989.565	456437.411	294.370
K 54	200998.224	456433.428	294.220
K 55	201004.014	456429.252	293.780
K 56	201006.686	456426.175	293.590
K 57	201036.949	456391.315	292.850
K 58	201084.211	456336.876	291.440
K 59	201104.635	456313.350	290.370
K 60	201105.732	456313.392	290.360
K 61	201106.333	456312.586	290.320
K 62	201022.239	456305.361	291.780

A/A	X	Y	H
K 63	201060.187	456387.512	293.300
K 64	201036.347	456408.971	292.950
K 65	201007.833	456434.637	293.830
K 66	201018.585	456513.962	300.850
K 67	201055.739	456521.828	301.630
K 68	201055.525	456522.429	301.660
K 69	201065.308	456494.945	300.200
K 70	201033.673	456487.360	299.670
K 71	201072.962	456473.444	299.030
K 72	201080.608	456451.961	297.680
K 73	201081.028	456438.564	296.890
K 74	201082.585	456388.801	294.230
K 75	201082.909	456378.466	293.680
K 76	201174.853	456381.676	294.750
K 77	201176.907	456316.068	290.910
K 78	201245.438	456318.650	291.140
K 79	201242.311	456348.118	292.700
K 80	201241.271	456361.775	293.580
K 81	201234.965	456444.543	298.150
K 82	201175.459	456442.232	297.820
K 83	201172.961	456442.135	297.850
K 84	201165.466	456441.844	297.790
K 85	201164.347	456477.622	300.090
K 86	201171.068	456477.930	300.140
K 87	201174.337	456478.079	300.170
K 88	201169.272	456524.008	302.540
K 89	201077.371	456519.580	301.630
K 90	201229.334	456526.798	302.830
K 91	201230.675	456504.045	301.730
K 92	201217.406	456503.482	301.710
K 93	201219.098	456480.126	300.300
K 94	201231.990	456481.716	300.400
K 95	201232.284	456481.730	300.410
K 96	201232.356	456480.732	300.370
K 97	201268.150	456483.370	300.480
K 98	201289.508	456484.347	300.490
K 99	201354.691	456488.725	299.860
K 100	201349.243	456533.104	302.390
K 101	201348.726	456537.310	302.800
K 102	201357.785	456455.865	298.130
K 103	201358.073	456451.374	297.930
K 104	201358.163	456449.876	297.850
K 105	201293.919	456446.895	298.350
K 106	201270.883	456445.938	298.620
K 107	201360.373	456413.326	295.830
K 108	201296.612	456409.025	296.200
K 109	201363.062	456368.853	293.470
K 110	201364.474	456345.493	292.460
K 111	201376.295	456324.461	290.840
K 112	201373.329	456324.320	290.860
K 113	201366.635	456324.000	290.910
K 114	201365.776	456323.959	290.910
K 115	201355.285	456323.496	290.980
K 117	201456.220	456328.281	290.050
K 118	201457.379	456328.336	290.010
K 119	201449.211	456372.884	292.340
K 120	201449.203	456373.384	292.360
K 121	201478.246	456374.411	292.510
K 122	201480.108	456374.509	292.470
K 123	201480.911	456351.732	291.260

A/A	X	Y	H
K 124	201475.143	456351.898	291.280
K 125	201479.660	456329.401	290.060
K 126	201476.501	456329.250	289.980
K 127	201474.188	456329.140	290.040
K 128	201469.622	456464.831	297.310
K 129	201467.170	456464.597	297.280
K 130	201464.934	456486.478	298.440
K 131	201462.929	456486.290	298.220
K 132	201436.913	456483.848	298.270
K 133	201435.847	456461.315	296.940
K 134	201435.561	456455.280	296.650
K 135	201436.070	456455.316	296.000
K 136	201437.519	456496.650	298.950
K 137	201439.895	456546.878	301.560
K 138	201466.778	456550.866	302.080
K 139	201470.090	456508.617	299.880
K 140	201461.405	456498.271	298.670
K 141	201507.697	456571.360	303.030
K 142	201510.519	456557.152	302.310
K 143	201520.357	456507.631	299.640
K 144	201523.468	456491.972	298.750
K 145	201525.851	456479.974	298.110
K 146	201535.474	456431.534	295.650
K 147	201546.113	456377.981	292.790
K 148	201545.863	456326.919	289.980
K 149	201545.894	456323.458	289.990
K 150	201640.229	456332.993	289.260
K 151	201637.527	456359.188	290.600
K 152	201631.091	456358.496	290.300
K 153	201629.706	456370.626	290.980
K 154	201636.280	456371.287	290.890
K 155	201659.338	456373.604	290.520
K 156	201665.197	456378.017	290.530
K 157	201664.505	456386.885	291.110
K 158	201740.220	456343.100	286.940
K 159	201732.669	456401.438	290.970
K 160	201668.387	456392.627	292.690
K 161	201667.176	456390.829	292.620
K 162	201684.674	456395.180	292.650
K 163	201645.298	456387.724	292.770
K 164	201642.508	456424.097	293.580
K 165	201665.298	456426.193	293.490
K 166	201641.266	456440.276	294.300
K 167	201617.452	456438.142	294.610
K 168	201610.266	456437.498	294.490
K 169	201608.698	456437.358	294.480
K 170	201608.588	456438.238	294.490
K 171	201600.240	456437.473	294.930
K 172	201597.102	456437.185	294.920
K 173	201597.526	456432.451	294.720
K 174	201610.617	456433.586	294.390
K 175	201612.627	456476.607	296.220
K 176	201603.904	456475.573	296.220
K 177	201602.124	456489.763	296.910
K 178	201602.062	456490.259	296.920
K 179	201593.759	456489.139	297.200
K 180	201593.427	456489.094	297.190
K 181	201591.805	456501.211	297.610
K 182	201600.538	456502.407	297.420
K 183	201598.466	456518.926	298.360

A/A	X	Y	H
K 184	201596.828	456531.985	299.590
K 185	201590.825	456579.841	302.070
K 186	201690.952	456590.057	299.920
K 187	201698.080	456571.197	297.860
K 188	201697.071	456549.261	298.200
K 189	201631.187	456542.531	299.470
K 190	201668.648	456539.321	297.840
K 191	201708.585	456543.400	295.890
K 192	201717.710	456519.255	294.990
K 193	201702.065	456517.311	295.460
K 194	201700.018	456535.510	296.490
K 195	201669.692	456531.311	297.500
K 196	201719.193	456505.562	294.300
K 197	201726.652	456447.927	292.040
K 198	201543.134	456218.435	284.700
K 199	201481.408	456219.297	284.810
K 200	201480.699	456258.993	286.420
K 201	201490.194	456259.101	286.610
K 202	201489.113	456290.193	288.390
K 203	201476.279	456290.199	288.030
K 204	201457.680	456299.884	288.550
K 205	201458.095	456260.667	286.460
K 206	201471.655	456219.434	284.790
K 207	201440.439	456219.870	284.610
K 208	201375.534	456298.448	289.510
K 209	201367.284	456298.304	289.520
K 210	201367.244	456299.889	289.520
K 211	201356.716	456299.818	289.900
K 212	201367.746	456279.981	288.630
K 213	201369.306	456217.801	285.210
K 214	201257.365	456211.236	285.170
K 215	201255.357	456228.775	286.180
K 216	201242.554	456227.901	286.220
K 217	201240.526	456251.632	287.330
K 218	201252.628	456252.612	287.350
K 219	201249.712	456278.369	289.000
K 220	201147.389	456205.674	284.480
K 221	201144.298	456243.838	286.680
K 222	201138.468	456263.249	287.820
K 223	201127.770	456283.880	289.090
K 224	201116.752	456298.634	289.770
K 225	201147.578	456300.941	290.160
K 226	201146.383	456314.920	290.760
K 227	201261.212	456177.636	283.400
K 228	201200.231	456173.371	283.610
K 229	201150.832	456169.915	282.670
K 230	201158.365	456092.395	278.810
K 231	201192.268	456095.270	279.320
K 232	201188.052	456137.025	281.500
K 233	201203.452	456138.550	281.710
K 234	201269.888	456101.852	279.710
K 235	201266.949	456127.526	280.960
K 236	201372.511	456134.641	280.560
K 237	201372.502	456136.143	280.610
K 238	201372.177	456136.121	280.650
K 239	201429.034	456139.953	280.550
K 240	201429.930	456140.014	280.600
K 241	201438.634	456168.454	281.660
K 242	201471.827	456181.531	282.830
K 243	201454.885	456181.781	280.760

A/A	X	Y	H
K 244	201455.277	456116.333	279.380
K 245	201450.721	456115.654	279.110
K 246	201426.800	456111.749	279.040
K 247	201543.970	456121.228	279.620
K 248	201544.559	456034.331	275.120
K 249	201441.900	456034.009	275.180
K 250	201441.687	456089.369	277.160
K 251	201451.275	456089.381	278.000
K 252	201435.855	456033.990	274.880
K 253	201429.050	456033.968	275.060
K 254	201423.213	456033.950	275.080
K 255	201423.421	456048.849	275.800
K 256	201428.620	456048.816	275.670
K 257	201384.056	456033.827	275.300
K 258	201384.291	456033.222	275.310
K 259	201383.467	456033.246	275.310
K 260	201304.675	456035.494	276.440
K 261	201280.197	456031.078	276.210
K 262	201278.847	456038.408	276.510
K 263	201303.379	456042.828	276.700
K 264	201278.662	456039.409	276.560
K 265	201272.633	456072.130	278.310
K 266	201273.287	456072.165	278.310
K 267	201271.713	456085.912	279.250
K 268	201299.746	456087.721	278.730
K 269	201372.804	456089.040	278.400
K 270	201372.975	456062.423	277.040
K 271	201161.167	456063.562	277.380
K 272	201228.114	456069.760	278.360
K 273	201164.766	456026.527	275.590
K 274	201165.313	456026.589	275.580
K 275	201182.468	455975.104	273.200
K 276	201198.179	455927.949	270.940
K 277	201200.109	455922.158	270.670
K 278	201236.271	455927.139	271.110
K 279	201235.262	455933.057	271.480
K 280	201299.417	455935.836	271.420
K 281	201288.739	455990.606	274.170
K 282	201288.294	455992.892	274.250
K 283	201287.274	455992.668	274.230
K 284	201353.240	456007.127	274.160
K 285	201388.305	456006.893	274.110
K 286	201389.932	456006.878	274.080
K 287	201435.353	456006.467	274.550
K 288	201473.689	456006.119	274.170
K 289	201522.552	456005.147	273.470
K 290	201522.456	456020.700	274.380
K 291	201545.007	456020.483	274.420
K 292	201545.354	456004.698	273.590
K 293	201545.704	455925.557	269.600
K 294	201474.317	455926.902	270.500
K 295	201465.179	455927.074	270.610
K 296	201411.734	455928.081	270.220
K 297	201396.416	455928.369	270.120
K 298	201396.456	455927.876	270.080
K 299	201304.290	455910.838	270.200
K 300	201303.307	455910.656	270.180
K 301	201209.707	455893.353	269.340
K 302	201224.543	455848.826	267.300
K 303	201312.801	455861.957	267.370

A/A	X	Y	H
K 304	201368.173	455868.505	267.360
K 305	201400.993	455872.946	268.440
K 306	201400.953	455873.428	268.440
K 307	201401.762	455873.439	268.420
K 308	201411.193	455873.561	268.180
K 309	201438.126	455873.912	268.130
K 310	201456.417	455874.033	268.110
K 311	201460.073	455874.057	268.000
K 312	201456.603	455886.910	268.600
K 313	201465.876	455887.104	268.590
K 314	201466.103	455874.097	267.960
K 315	201466.422	455855.845	267.160
K 316	201459.944	455855.619	267.230
K 317	201466.690	455853.146	267.070
K 318	201525.922	455853.494	266.000
K 319	201525.899	455871.661	266.860
K 320	201545.943	455871.458	267.090
K 321	201546.021	455853.613	266.190
K 322	201546.291	455792.568	263.170
K 323	201473.163	455792.195	264.060
K 324	201474.055	455815.408	265.130
K 325	201400.171	455791.822	264.130
K 326	201400.194	455793.016	264.030
K 327	201374.448	455802.499	264.000
K 328	201374.426	455802.120	264.000
K 329	201373.158	455801.926	264.020
K 330	201325.908	455794.724	264.130
K 331	201319.878	455825.654	265.590
K 332	201315.314	455849.068	266.870
K 333	201304.839	455847.704	266.940
K 334	201309.760	455823.887	265.670
K 335	201240.423	455811.774	265.500
K 336	201229.411	455834.217	266.580
K 337	201254.156	455783.786	264.040
K 338	201274.578	455742.165	261.910
K 339	201295.075	455701.118	260.030
K 340	201375.999	455755.531	261.640
K 341	201377.713	455755.580	261.660
K 342	201373.488	455785.730	263.340
K 343	201399.453	455755.026	261.820
K 344	201399.620	455763.601	262.180
K 345	201472.058	455763.451	262.860
K 346	201468.903	455687.687	258.690
K 347	201546.754	455687.724	258.230
K 348	201398.137	455687.543	258.610
K 349	201398.623	455712.496	259.100
K 350	201378.736	455713.932	259.880
K 351	201378.744	455713.589	259.840
K 352	201389.411	455687.510	257.240
K 353	201378.206	455687.074	258.450
K 354	201304.296	455682.721	259.130
K 355	201349.157	455593.220	254.860
K 356	201353.953	455580.225	254.220
K 357	201361.086	455562.602	253.420
K 358	201360.630	455562.420	253.410
K 359	201361.643	455559.675	253.280
K 360	201381.042	455570.562	253.380
K 361	201388.325	455571.372	253.290
K 362	201387.743	455595.816	253.910
K 363	201379.593	455628.546	255.800

A/A	X	Y	H
K 364	201390.084	455663.347	257.360
K 365	201398.731	455663.328	257.670
K 366	201399.931	455622.883	255.440
K 367	201403.423	455622.917	255.410
K 368	201404.133	455597.952	255.140
K 369	201421.137	455597.999	255.060
K 370	201421.814	455572.016	253.380
K 371	201470.833	455572.959	252.920
K 372	201470.850	455571.963	252.930
K 373	201470.644	455584.194	253.500
K 374	201479.832	455584.162	253.410
K 375	201480.163	455572.166	252.810
K 376	201547.056	455619.484	254.880
K 377	201539.549	455573.457	252.690
K 378	201533.958	455539.181	251.020
K 379	201500.019	455536.925	250.740
K 380	201482.819	455536.106	250.930
K 381	201468.846	455535.352	251.080
K 382	201416.566	455531.782	251.350
K 383	201395.461	455530.128	251.360
K 384	201375.738	455521.465	251.590
K 385	201375.428	455521.329	251.580
K 386	201385.035	455498.025	250.530
K 387	201391.697	455485.238	249.850
K 388	201471.243	455491.306	249.250
K 389	201469.984	455508.334	250.030
K 390	201469.248	455521.617	250.680
K 391	201526.842	455495.548	248.970
K 392	201513.221	455412.036	245.390
K 393	201500.112	455331.664	242.430
K 394	201460.834	455373.863	244.580
K 395	201442.837	455398.932	245.720
K 396	201432.541	455413.276	246.380
K 397	201420.320	455430.299	247.300
K 398	201429.437	455389.252	246.000
K 399	201412.303	455412.055	247.210
K 400	201409.987	455410.633	247.140
K 401	201392.057	455442.500	248.480
K 402	201380.705	455449.023	248.740
K 403	201363.534	455480.463	249.800
K 404	201336.134	455553.845	253.730
K 405	201735.217	456381.749	288.680
K 406	201722.546	456380.276	289.010
K 407	201722.898	456371.080	288.570
K 408	201736.390	456372.689	288.220
K 409	200889.048	456371.142	299.780
K 410	200883.803	456400.549	300.990
K 411	201631.899	456535.567	298.630
K 412	201411.632	456220.272	285.030
K 413	201445.589	456395.932	293.470
K 414	201372.027	456345.854	292.210
K 415	200798.580	456271.702	304.000
K 416	201546.043	456362.219	291.880
K 417	201438.500	456219.897	284.620
K 418	201143.973	456243.812	286.680

ΕΞΑΣΦΑΛΙΣΕΙΣ ΑΕΟΝΟΔΙΑΣΤΑΥΡΩΣΕΩΝ

ΕΞΑΣΦΑΛΙΣΕΙΣ ΚΟΡΥΦΩΝ

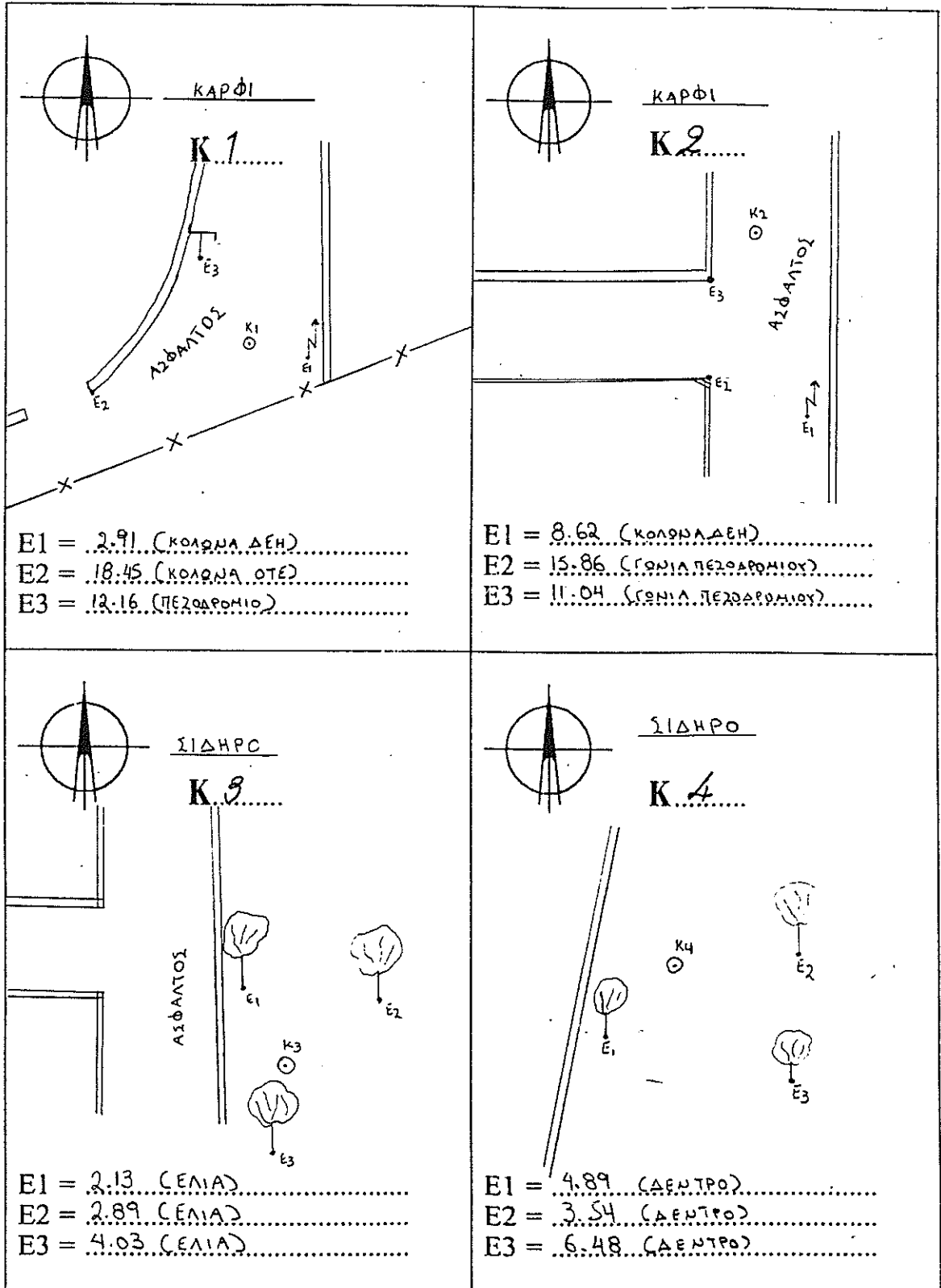

ΕΞΑΣΦΑΛΙΣΕΙΣ ΚΟΡΥΦΩΝ

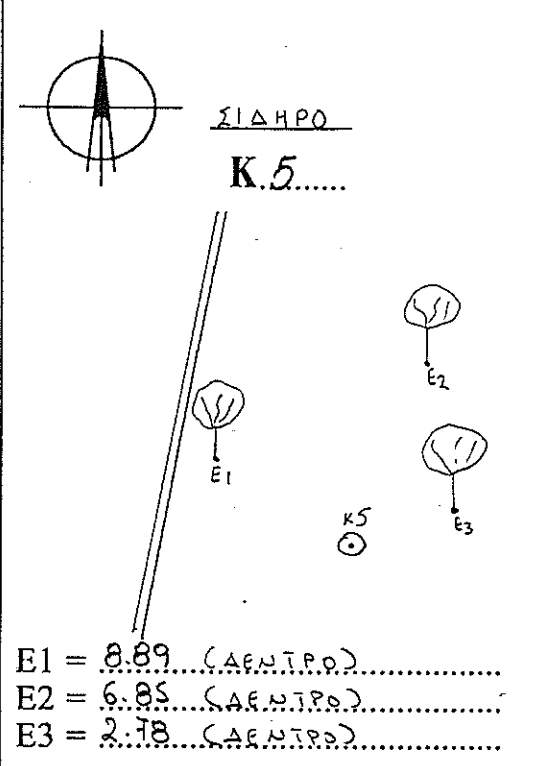
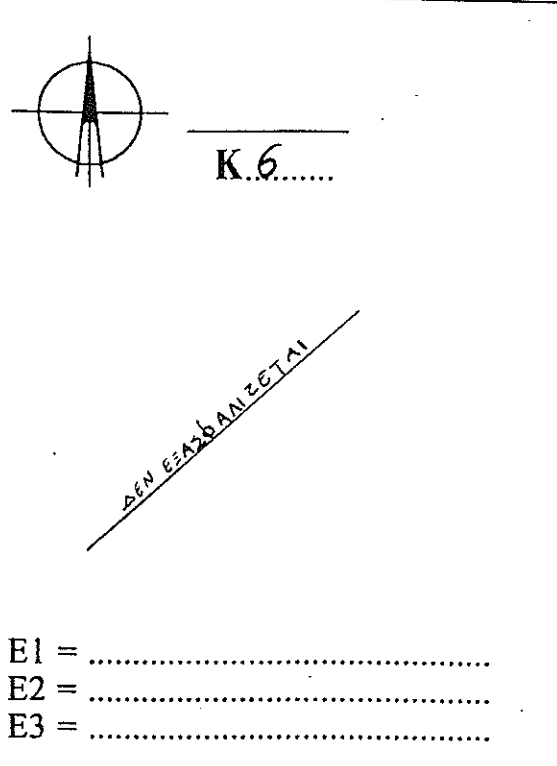
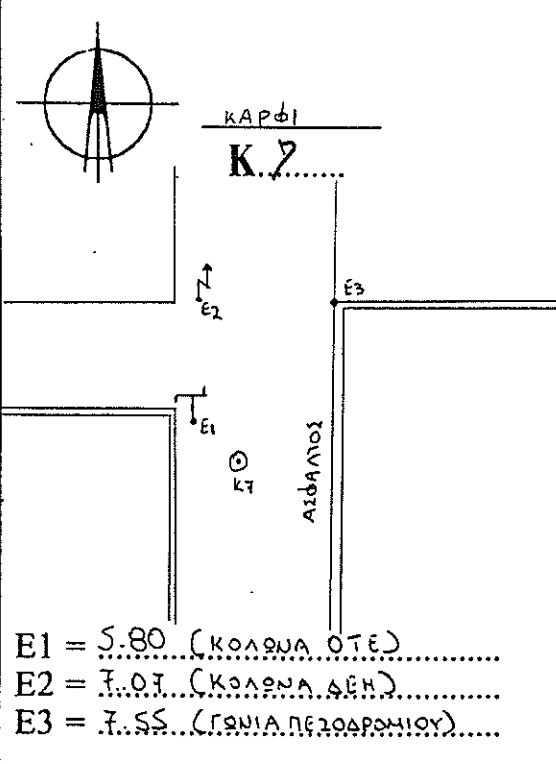
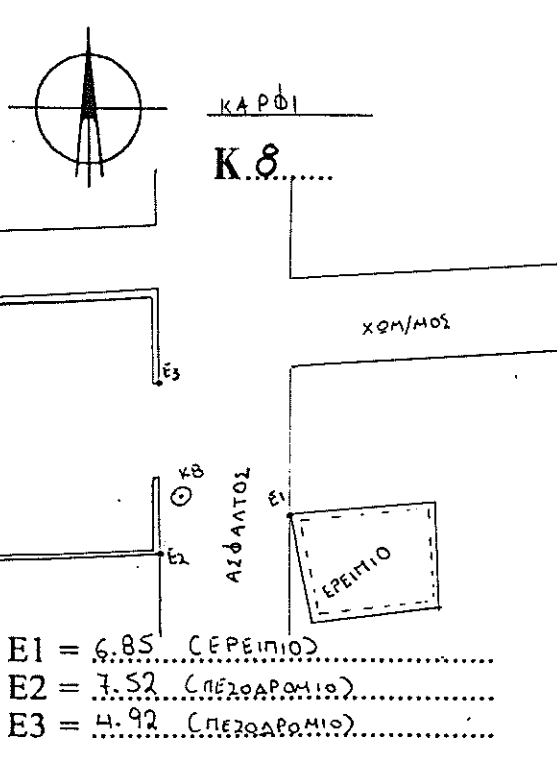
 <p>ΣΙΔΗΡΟ Κ.5.....</p> <p>E1 = 8.89 (ΔΕΝΤΡΟ)..... E2 = 6.85 (ΔΕΝΤΡΟ)..... E3 = 2.78 (ΔΕΝΤΡΟ).....</p>	 <p>Κ.6.....</p> <p>E1 = E2 = E3 =</p>
 <p>ΚΑΡΦΙ Κ.7.....</p> <p>E1 = 5.80 (ΚΟΛΩΝΑ ΟΤΕ)..... E2 = 7.07 (ΚΟΛΩΝΑ ΔΕΗ)..... E3 = 7.55 (ΓΩΝΙΑ ΠΕΖΟΔΡΟΜΙΟΥ).....</p>	 <p>ΚΑΡΦΙ Κ.8.....</p> <p>E1 = 6.85 (ΕΡΕΠΙΟ)..... E2 = 7.52 (ΠΕΖΟΔΡΟΜΙΟ)..... E3 = 4.92 (ΠΕΖΟΔΡΟΜΙΟ).....</p>

ΕΞΑΣΦΑΛΙΣΕΙΣ ΚΟΡΥΦΩΝ

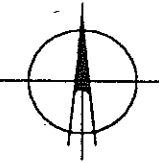
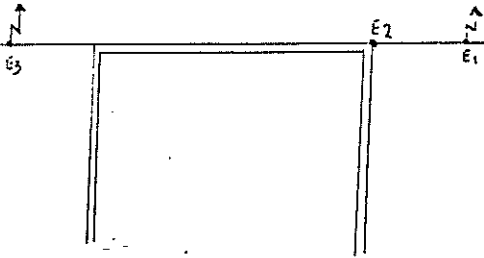
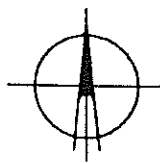
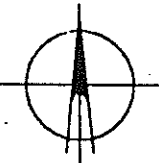
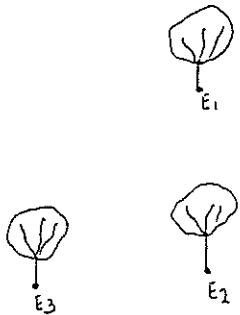
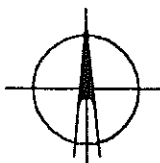
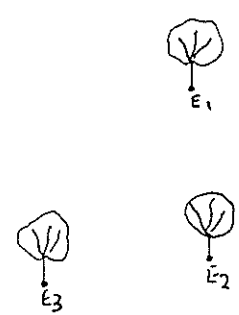
 <p>ΣΤΑΘΗΡΟ Κ.9.....</p> <p>X — X — X — X — X ΧΩΜ/ΜΟΣ</p> <p>⊙ Κ9</p>  <p>E1 = 18.94 (ΚΟΛΩΝΑ ΔΕΗ)..... E2 = 4.01 (ΓΩΝΙΑ ΜΑΝΤΡΑΣ)..... E3 = 11.73 (ΚΟΛΩΝΑ ΔΕΗ).....</p>	 <p>Κ.10.....</p> <p>E1 = E2 = E3 =</p>
 <p>ΣΤΑΘΗΡΟ Κ.11.....</p>  <p>⊙ Κ11</p> <p>E1 = 7.40 (ΕΛΙΑ)..... E2 = 6.11 (ΕΛΙΑ)..... E3 = 1.82 (ΕΛΙΑ).....</p>	 <p>ΣΤΑΘΗΡΟ Κ.12.....</p>  <p>⊙ Κ12</p> <p>E1 = 7.64 (ΕΛΙΑ)..... E2 = 6.03 (ΕΛΙΑ)..... E3 = 1.45 (ΕΛΙΑ).....</p>

ΕΞΑΣΦΑΛΙΣΕΙΣ ΚΟΡΥΦΩΝ

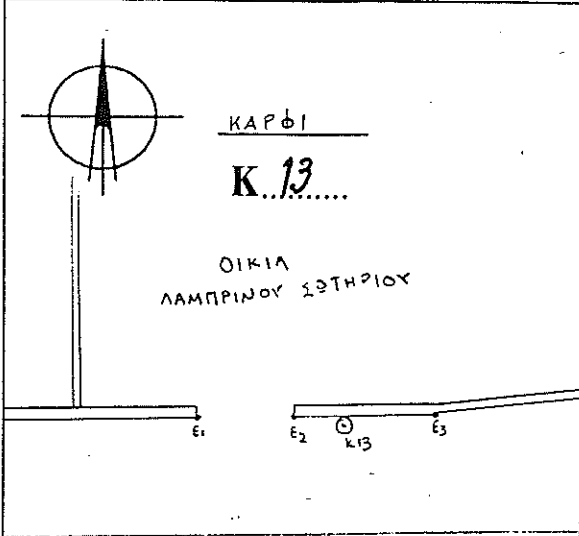
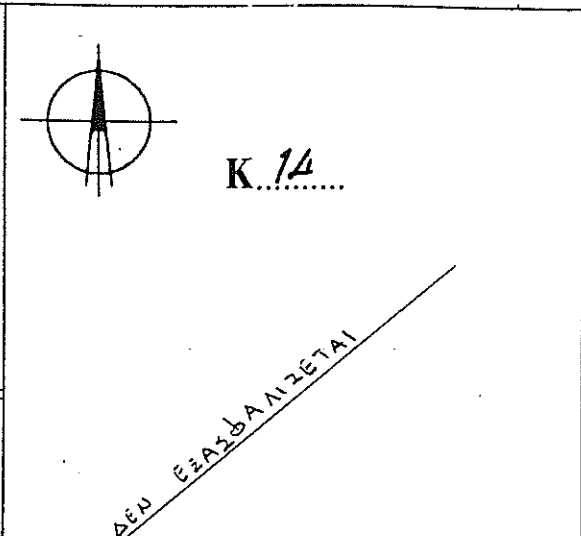
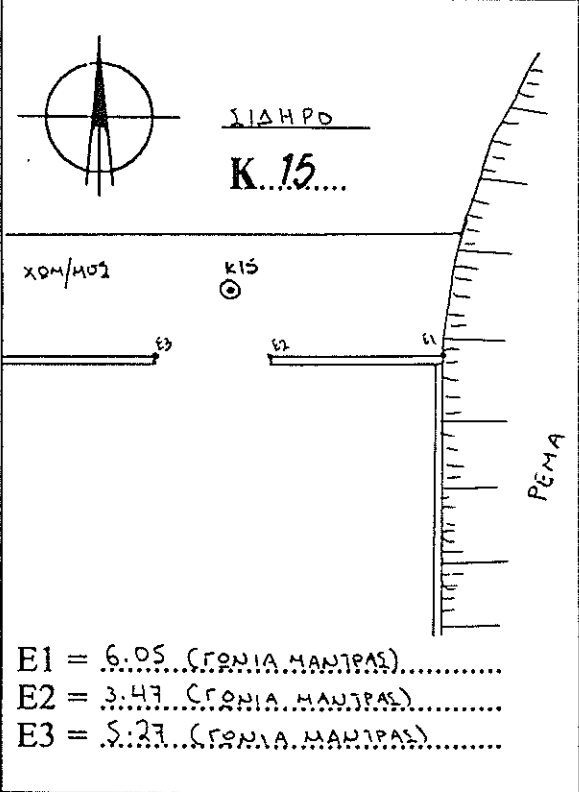
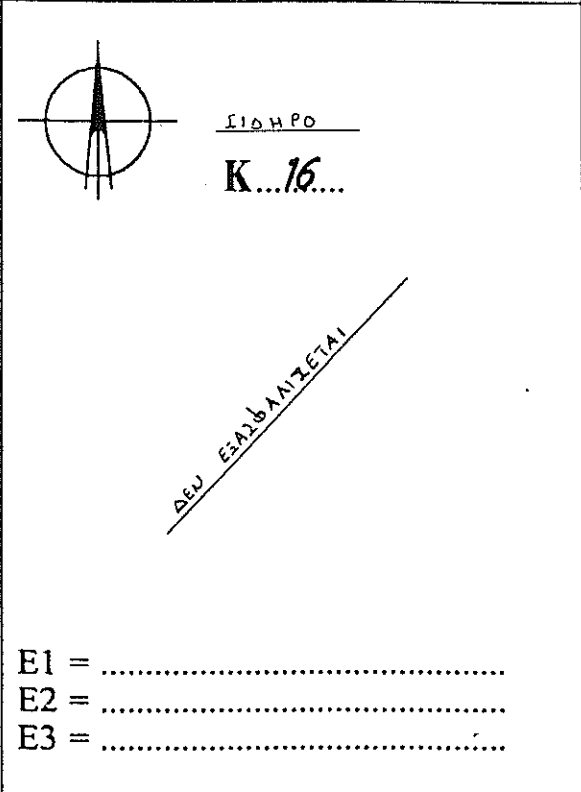
 <p>ΚΑΡΦΙ K. 13</p> <p>ΟΙΚΙΑ ΛΑΜΠΡΙΝΟΥ ΣΩΤΗΡΙΟΥ</p>	 <p>K. 14</p> <p>ΔΕΥ ΕΞΑΣΦΑΛΙΖΕΤΑΙ</p>
<p>E1 = 3.78 (ΜΑΝΤΡΑ ΟΙΚΙΑΣ).....</p> <p>E2 = 2.08 (ΜΑΝΤΡΑ ΟΙΚΙΑΣ).....</p> <p>E3 = 3.43 (ΜΑΝΤΡΑ ΟΙΚΙΑΣ).....</p>	<p>E1 =</p> <p>E2 =</p> <p>E3 =</p>
 <p>ΣΙΔΗΡΟ K. 15</p> <p>ΧΟΜ/ΜΟΥ</p> <p>ΡΕΜΑ</p>	 <p>ΣΙΔΗΡΟ K. 16</p> <p>ΔΕΥ ΕΞΑΣΦΑΛΙΖΕΤΑΙ</p>
<p>E1 = 6.05 (ΓΩΝΙΑ ΜΑΝΤΡΑΣ).....</p> <p>E2 = 3.47 (ΓΩΝΙΑ ΜΑΝΤΡΑΣ).....</p> <p>E3 = 5.27 (ΓΩΝΙΑ ΜΑΝΤΡΑΣ).....</p>	<p>E1 =</p> <p>E2 =</p> <p>E3 =</p>

ΕΞΑΣΦΑΛΙΣΕΙΣ ΚΟΡΥΦΩΝ

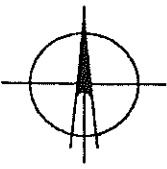
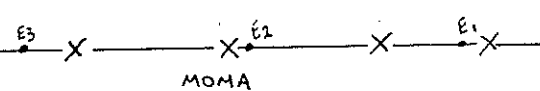
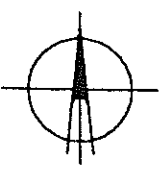
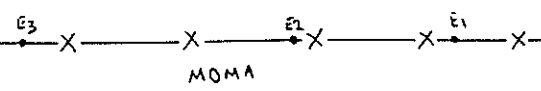
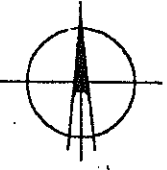
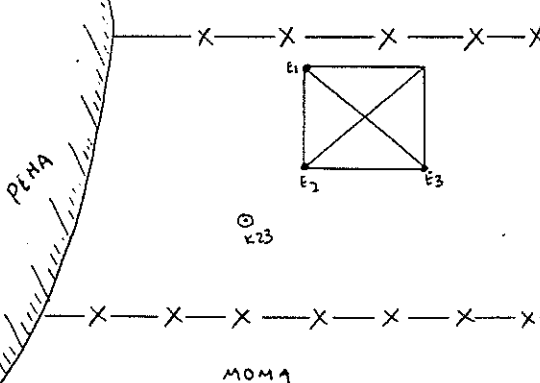
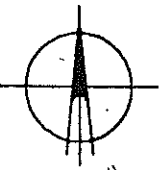
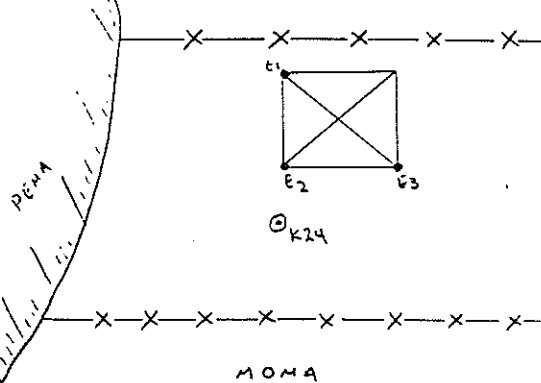
<div style="text-align: center;">  <p>ΣΙΑΗΡΟ Κ.21.....</p> <p>ΕΛΑΙΩΝΑΣ</p> <p>⊙ K21</p> </div> <div style="text-align: center; margin-top: 20px;">  </div> <div style="margin-top: 20px;"> <p>E1 = 6.54 (ΣΙΑΗΡΟΠΑΣΣΑΛΟΣ).....</p> <p>E2 = 4.53 (ΣΙΑΗΡΟΠΑΣΣΑΛΟΣ).....</p> <p>E3 = 4.97 (ΣΙΑΗΡΟΠΑΣΣΑΛΟΣ).....</p> </div>	<div style="text-align: center;">  <p>ΣΙΑΗΡΟ Κ.22.....</p> <p>ΕΛΑΙΩΝΑΣ</p> <p>⊙ K22</p> </div> <div style="text-align: center; margin-top: 20px;">  </div> <div style="margin-top: 20px;"> <p>E1 = 7.55 (ΣΙΑΗΡΟΠΑΣΣΑΛΟΣ).....</p> <p>E2 = 5.25 (ΣΙΑΗΡΟΠΑΣΣΑΛΟΣ).....</p> <p>E3 = 6.52 (ΣΙΑΗΡΟΠΑΣΣΑΛΟΣ).....</p> </div>
<div style="text-align: center;">  <p>ΚΑΡΦΙ Κ.23.....</p> <p>ΡΕΥΜΑ</p> <p>⊙ K23</p> </div> <div style="text-align: center; margin-top: 20px;">  </div> <div style="margin-top: 20px;"> <p>E1 = 4.20 (ΓΩΝΙΑ ΒΕΡΑΝΤΑΣ).....</p> <p>E2 = 1.26 (ΓΩΝΙΑ ΒΕΡΑΝΤΑΣ).....</p> <p>E3 = 4.25 (ΓΩΝΙΑ ΒΕΡΑΝΤΑΣ).....</p> </div>	<div style="text-align: center;">  <p>ΚΑΡΦΙ Κ.24.....</p> <p>ΡΕΥΜΑ</p> <p>⊙ K24</p> </div> <div style="text-align: center; margin-top: 20px;">  </div> <div style="margin-top: 20px;"> <p>E1 = 4.52 (ΓΩΝΙΑ ΒΕΡΑΝΤΑΣ).....</p> <p>E2 = 1.05 (ΓΩΝΙΑ ΒΕΡΑΝΤΑΣ).....</p> <p>E3 = 3.83 (ΓΩΝΙΑ ΒΕΡΑΝΤΑΣ).....</p> </div>

ΕΞΑΣΦΑΛΙΣΕΙΣ ΚΟΡΥΦΩΝ

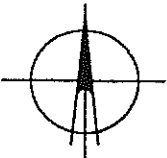
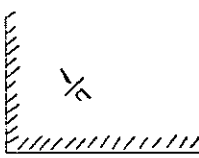
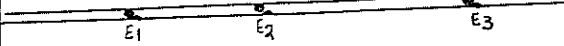
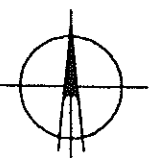
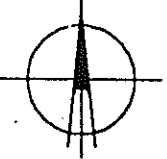
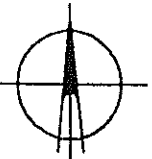
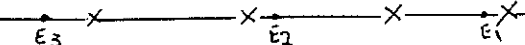
 <p>ΣΙΔΗΡΟ Κ. 17.....</p>   <p>⊙ Κ17</p> <p>ΕΛΛΙΩΝΑΣ</p> <p>E1 = 10.32 (ΜΑΝΤΡΑ)..... E2 = 6.56 (ΜΑΝΤΡΑ)..... E3 = 11.16 (ΜΑΝΤΡΑ).....</p>	 <p>Κ. 18.....</p> <p>E1 = E2 = E3 =</p>
 <p>Κ. 19.....</p> <p>E1 = E2 = E3 =</p>	 <p>ΣΙΔΗΡΟ Κ. 20.....</p> <p>ΕΛΛΙΩΝΑΣ</p> <p>⊙ Κ20</p>  <p>ΜΟΜΑ</p> <p>E1 = 6.80 (ΣΙΔΗΡΟΠΑΣΣΑΛΟΣ)..... E2 = 4.93 (ΣΙΔΗΡΟΠΑΣΣΑΛΟΣ)..... E3 = 5.32 (ΣΙΔΗΡΟΠΑΣΣΑΛΟΣ).....</p>

ΕΞΑΣΦΑΛΙΣΕΙΣ ΚΟΡΥΦΩΝ

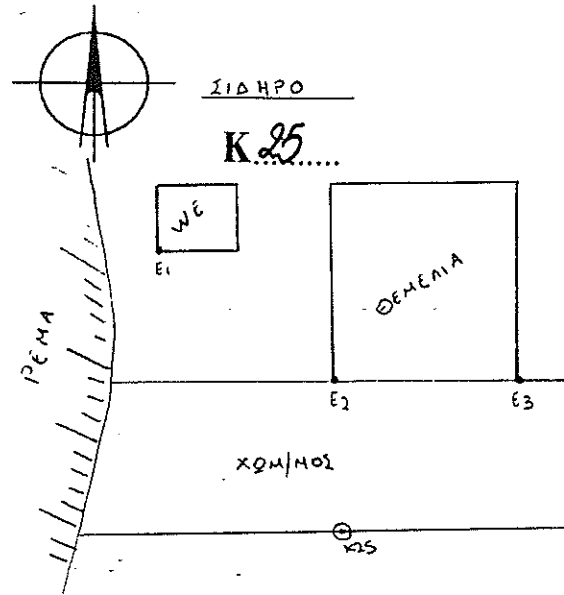
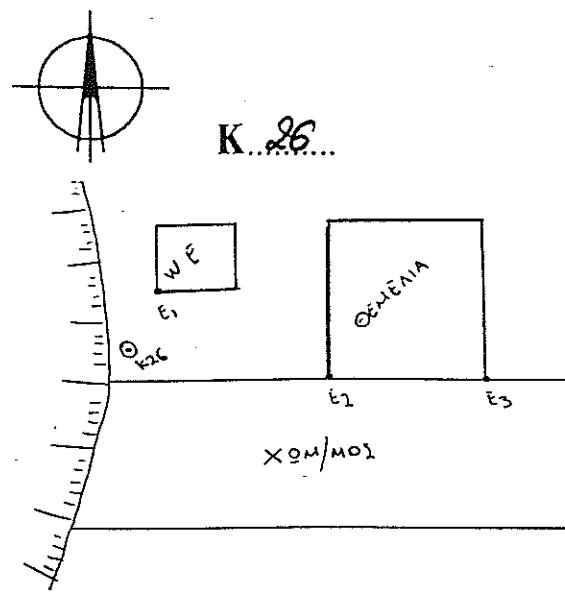
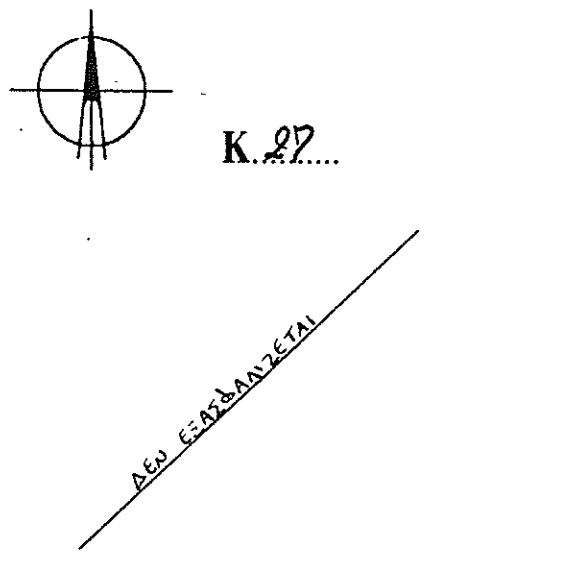
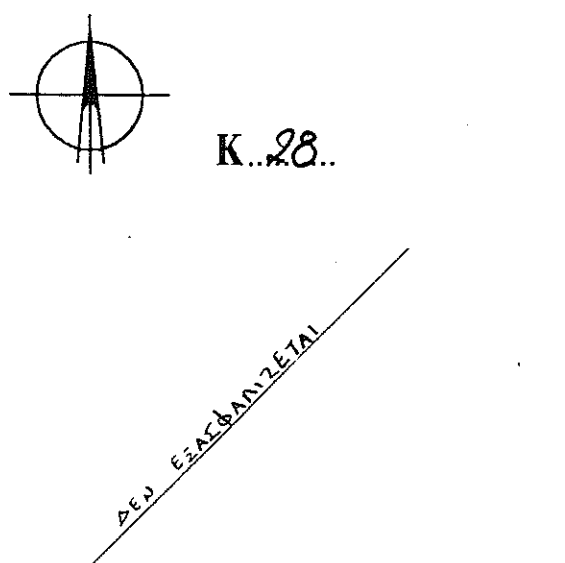
 <p style="text-align: center;">Κ.25</p> <p style="text-align: center;">ΧΩΜ/ΜΟΙ</p> <p>E1 = 10.25 (ΓΩΝΙΑ WE) E2 = 6.24 (ΓΩΝΙΑ ΚΤΙΣΜΑΤΟΣ) E3 = 13.58 (ΓΩΝΙΑ ΚΤΙΣΜΑΤΟΣ)</p>	 <p style="text-align: center;">Κ.26</p> <p style="text-align: center;">ΧΩΜ/ΜΟΙ</p> <p>E1 = 3.71 (ΓΩΝΙΑ WE) E2 = 4.95 (ΓΩΝΙΑ ΚΤΙΣΜΑΤΟΣ) E3 = 17.30 (ΓΩΝΙΑ ΚΤΙΣΜΑΤΟΣ)</p>
 <p style="text-align: center;">Κ.27</p> <p>ΔΕΝ ΕΞΑΣΦΑΛΙΖΕΤΑΙ</p> <p>E1 = E2 = E3 =</p>	 <p style="text-align: center;">Κ.28</p> <p>ΔΕΝ ΕΞΑΣΦΑΛΙΖΕΤΑΙ</p> <p>E1 = E2 = E3 =</p>

ΕΞΑΣΦΑΛΙΣΕΙΣ ΚΟΡΥΦΩΝ

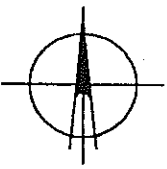
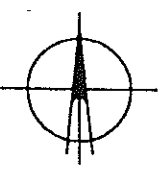
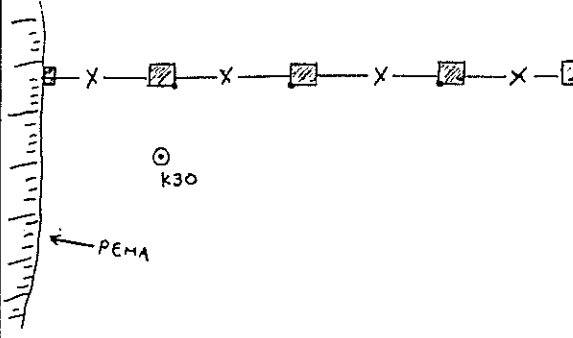
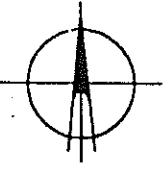
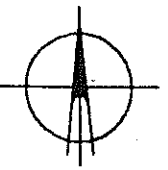
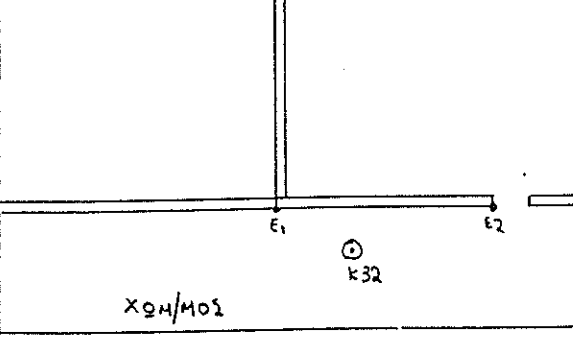
 <p>K.29...</p> <p>E1 =</p> <p>E2 =</p> <p>E3 =</p>	 <p>ΣΤΑΘΡΟ</p> <p>K.30...</p>  <p>⊙ K30</p> <p>← ΡΕΜΑ</p> <p>E1 = 1.06 (ΚΟΛΩΡΑΚΙ).....</p> <p>E2 = 4.23 (ΚΟΛΩΡΑΚΙ).....</p> <p>E3 = 7.76 (ΚΟΛΩΡΑΚΙ).....</p>
 <p>K.31...</p> <p><i>ΔΕΝ ΕΞΑΣΦΑΛΙΖΕΤΑΙ</i></p> <p>E1 =</p> <p>E2 =</p> <p>E3 =</p>	 <p>ΣΤΑΘΡΟ</p> <p>K.32...</p>  <p>⊙ K32</p> <p>ΧΩΜ/ΜΟΣ</p> <p>E1 = 3.85 (ΓΟΝΙΑ ΜΑΝΤΡΑΣ).....</p> <p>E2 = 4.67 (ΓΟΝΙΑ ΜΑΝΤΡΑΣ).....</p> <p>E3 = ΔΕΝ ΕΞΑΣΦΑΛΙΖΕΤΑΙ.....</p>

ΕΞΑΣΦΑΛΙΣΕΙΣ ΚΟΡΥΦΩΝ

<p>ΣΙΔΗΡΟ Κ.33...</p> <p>Ε1 = 9.47 (ΣΙΔΗΡΟΠΑΣΣΑΛΟΣ)..... Ε2 = 4.97 (ΚΟΛΩΝΑ ΟΔΟΥ)..... Ε3 = 4.72 (ΣΙΔΗΡΟΠΑΣΣΑΛΟΣ).....</p>	<p>Κ.34..</p> <p>Ε1 = Ε2 = Ε3 =</p>
<p>ΣΙΔΗΡΑ Κ.35...</p> <p>ΔΕΝ ΕΞΑΣΦΑΛΙΖΕΤΑΙ</p> <p>Ε1 = Ε2 = Ε3 =</p>	<p>ΣΙΔΗΡΟ Κ.36...</p> <p>ΧΩΜ/ΜΟΣ</p> <p>Ε1 = Ε2 = Ε3 =</p>

ΕΞΑΣΦΑΛΙΣΕΙΣ ΚΟΡΥΦΩΝ

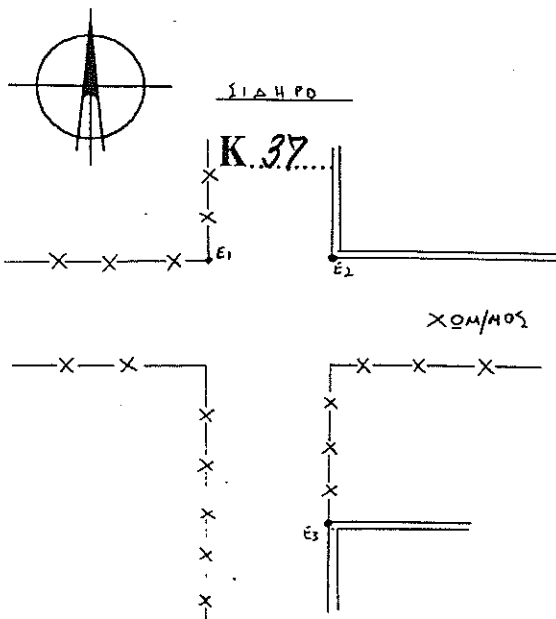
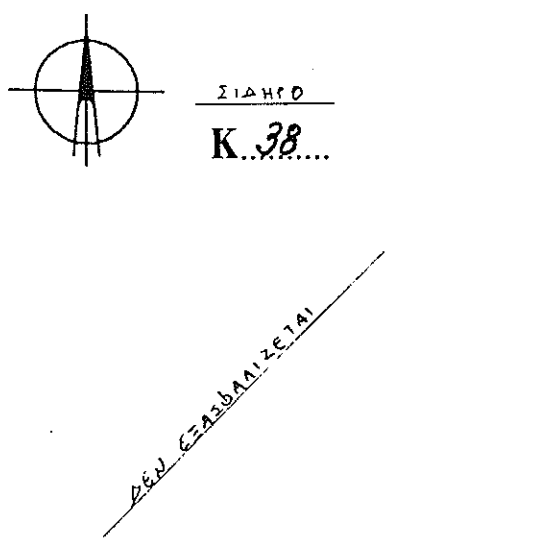
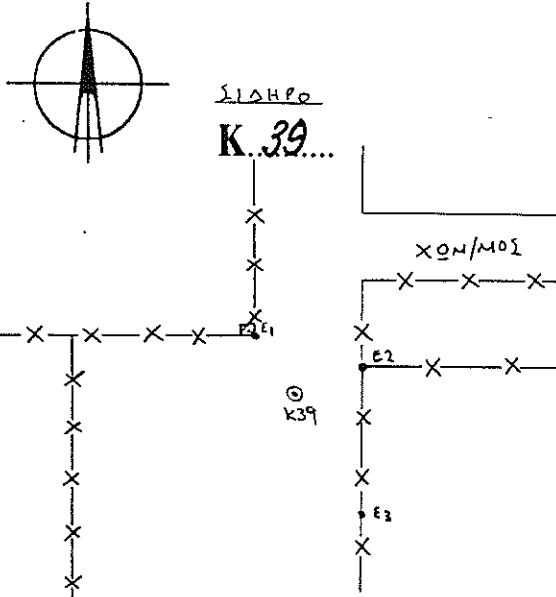
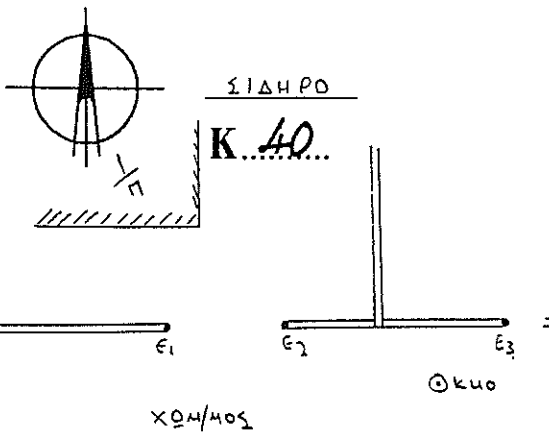
 <p>ΣΙΑΗΡΟ K.37</p> <p>Ε1</p> <p>Ε2</p> <p>ΧΟΜ/ΜΟΣ</p> <p>Ε3</p> <p>E1 = 3.51 (ΣΙΑΗΡΟΠΑΣΣΑΛΟΣ) E2 = 3.28 (ΓΩΝΙΑ ΜΑΝΤΡΑΣ) E3 = 14.65 (ΓΩΝΙΑ ΜΑΝΤΡΑΣ)</p>	 <p>ΣΙΑΗΡΟ K.38</p> <p>ΔΕΥ. ΕΞΑΣΦΑΛΙΖΕΤΑΙ</p> <p>E1 = E2 = E3 =</p>
 <p>ΣΙΑΗΡΟ K.39</p> <p>Ε1</p> <p>Ε2</p> <p>Ε3</p> <p>ΧΟΜ/ΜΟΣ</p> <p>Ⓞ K39</p> <p>E1 = 3.13 (ΣΤΑΙΜΕΝΤΟΚΟΛΩΝΑ) E2 = 2.38 (ΣΙΑΗΡΟΠΑΣΣΑΛΟΣ) E3 = 6.66 (ΣΙΑΗΡΟΠΑΣΣΑΛΟΣ)</p>	 <p>ΣΙΑΗΡΟ K.40</p> <p>Ε1</p> <p>Ε2</p> <p>Ε3</p> <p>ΧΟΜ/ΜΟΣ</p> <p>Ⓞ K40</p> <p>E1 = 7.52 (ΓΩΝΙΑ ΜΑΝΤΡΑΣ) E2 = 4.75 (ΓΩΝΙΑ ΜΑΝΤΡΑΣ) E3 = 6.15 (ΓΩΝΙΑ ΜΑΝΤΡΑΣ)</p>

ΕΞΑΣΦΑΛΙΣΕΙΣ ΚΟΡΥΦΩΝ

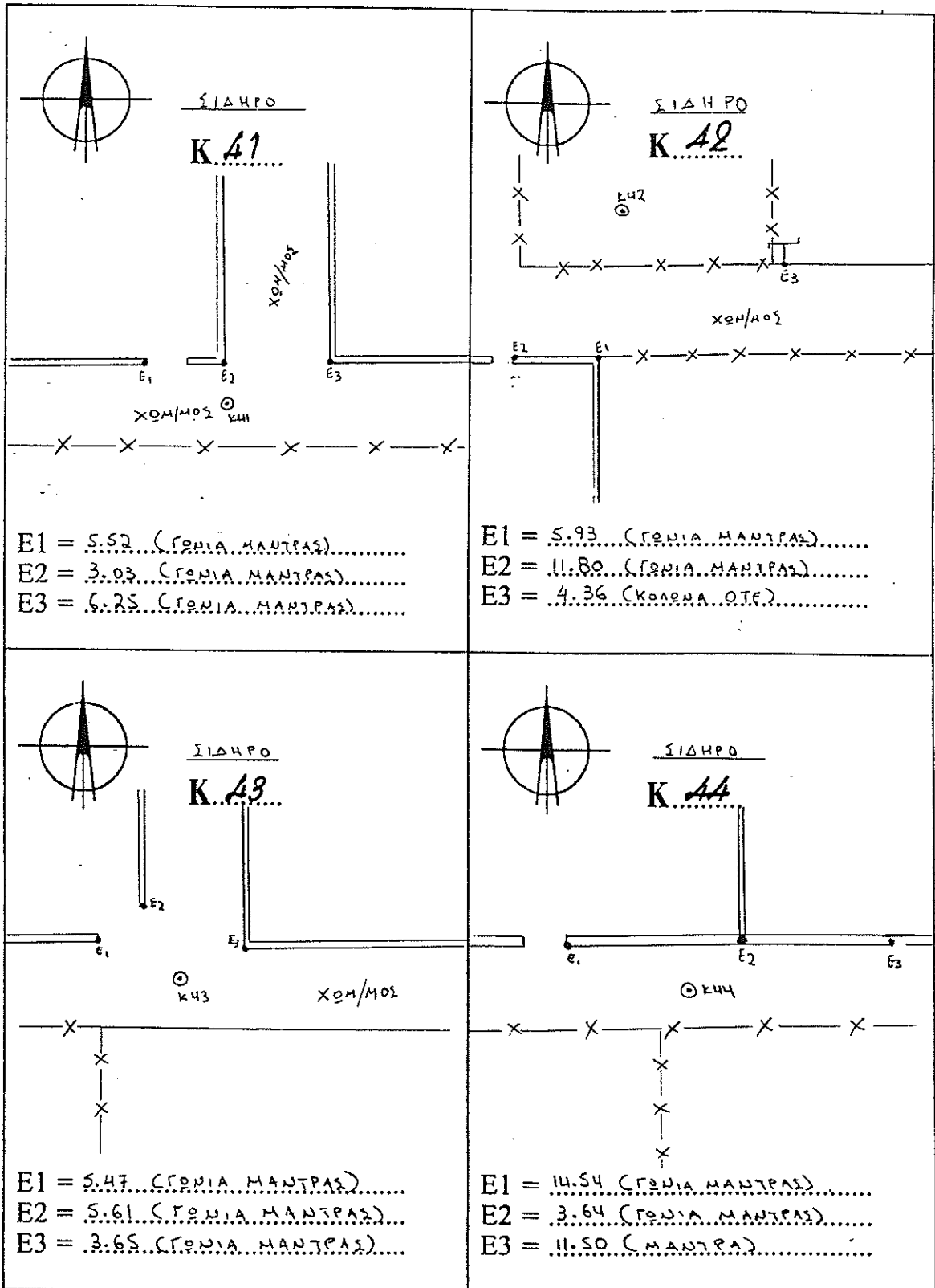

ΕΞΑΣΦΑΛΙΣΕΙΣ ΚΟΡΥΦΩΝ

<div style="display: flex; align-items: center; justify-content: center;"> <div style="text-align: center;"> <p>ΣΙΑΗΡΟ</p> <p>Κ. 45</p> </div> </div>	<div style="display: flex; align-items: center; justify-content: center;"> <div style="text-align: center;"> <p>ΣΙΑΗΡΟ</p> <p>Κ. 46</p> </div> </div>
<p>E1 =</p> <p>E2 =</p> <p>E3 =</p>	<p style="text-align: center;">ΧΩΜ/ΜΟΣ</p> <div style="text-align: center;"> </div> <p style="text-align: center;">⊙ κ46</p> <div style="text-align: center;"> </div> <p>E1 = 10.83 (ΓΩΝΙΑ ΟΙΚΙΑΣ).....</p> <p>E2 = 6.91 (ΓΩΝΙΑ ΜΑΝΤΡΑΣ).....</p> <p>E3 = 7.40 (ΓΩΝΙΑ ΜΑΝΤΡΑΣ).....</p>
<div style="display: flex; align-items: center; justify-content: center;"> <div style="text-align: center;"> <p>ΣΙΑΗΡΟ</p> <p>Κ. 47</p> <p style="writing-mode: vertical-rl; transform: rotate(180deg);">ΧΩΜ/ΜΟΣ</p> </div> </div>	<div style="display: flex; align-items: center; justify-content: center;"> <div style="text-align: center;"> <p>ΣΙΑΗΡΟ</p> <p>Κ. 48</p> <p style="writing-mode: vertical-rl; transform: rotate(180deg);">ΧΩΜ/ΜΟΣ</p> </div> </div>
<p style="text-align: center;">⊙ κ47</p> <div style="text-align: center;"> </div> <p style="text-align: center;">ΜΟΜΜ</p> <p>E1 = 6.70 (ΣΙΑΗΡΟΠΑΣΣΑΛΟΣ).....</p> <p>E2 = 4.65 (ΣΙΑΗΡΟΠΑΣΣΑΛΟΣ).....</p> <p>E3 = 4.78 (ΣΙΑΗΡΟΠΑΣΣΑΛΟΣ).....</p>	<p style="text-align: center;">⊙ κ48</p> <div style="text-align: center;"> </div> <p style="text-align: center;">ΧΩΜ/ΜΟΣ</p> <p>E1 = 3.93 (ΚΟΛΩΝΑ ΟΤΕ).....</p> <p>E2 = 7.67 (ΓΩΝΙΑ ΜΑΝΤΡΑΣ).....</p> <p>E3 = 2.16 (ΚΟΛΩΝΑ ΔΕΗ).....</p>

ΕΞΑΣΦΑΛΙΣΕΙΣ ΚΟΡΥΦΩΝ

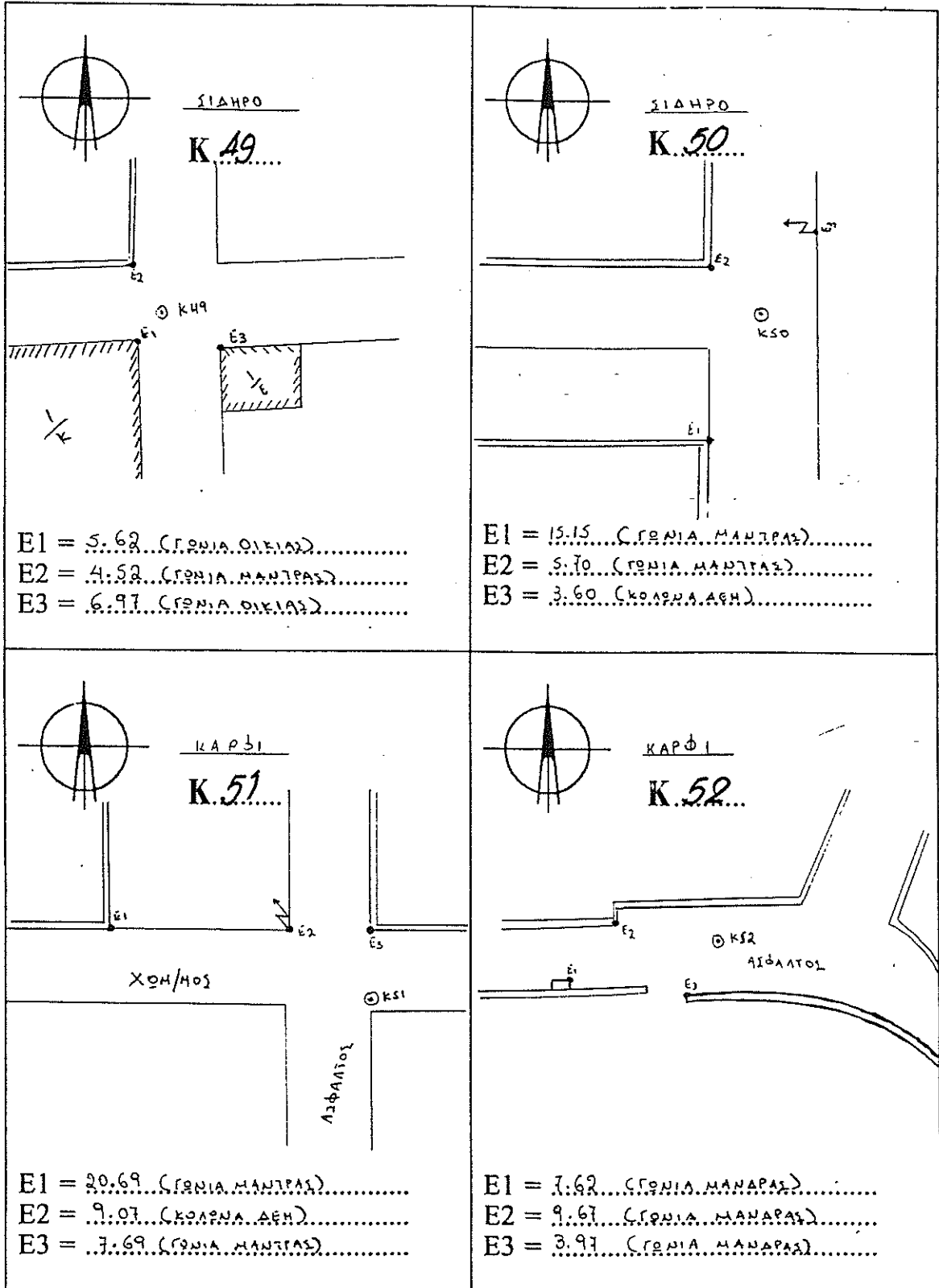

ΕΞΑΣΦΑΛΙΣΕΙΣ ΚΟΡΥΦΩΝ

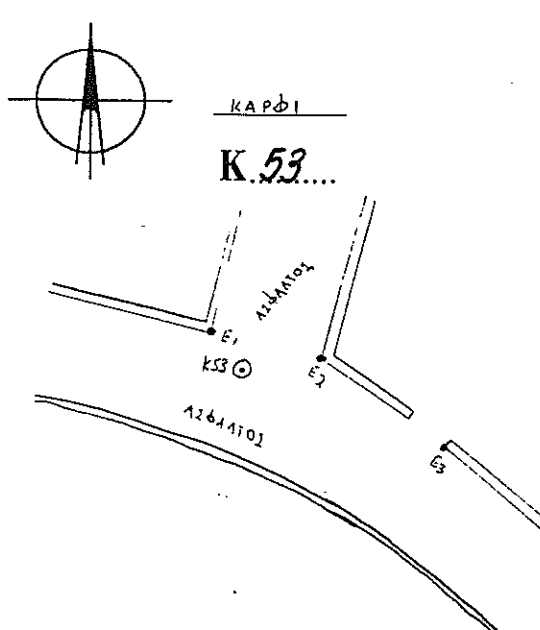
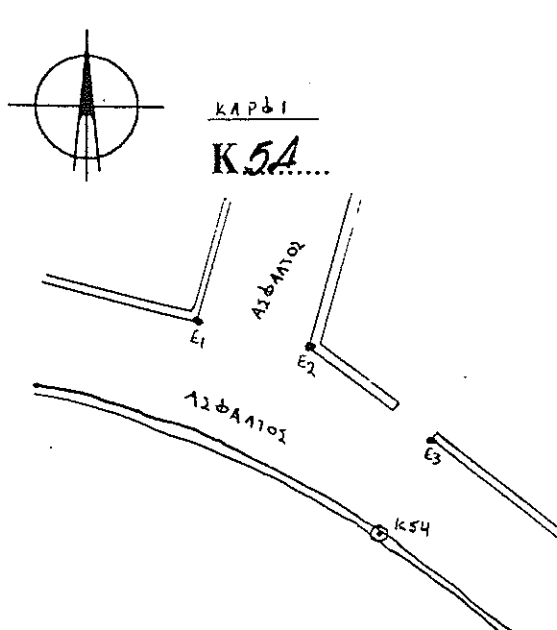
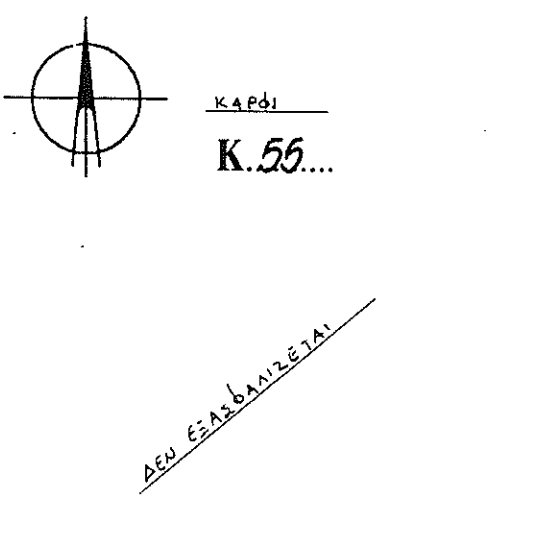
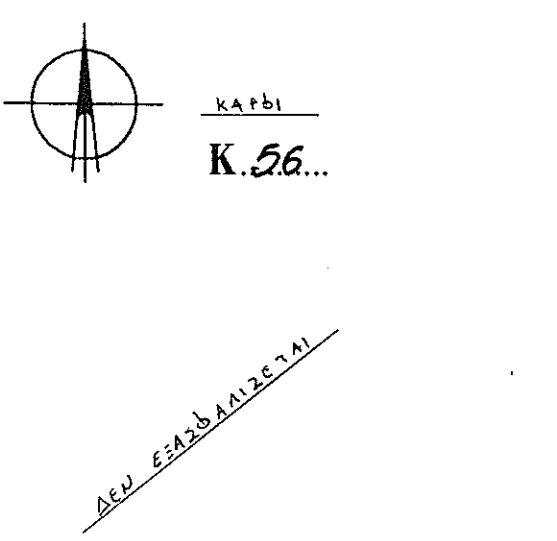
 <p>ΚΑΡΦΙ K.53...</p> <p>Ε1 = 7.67 (ΓΩΝΙΑ ΜΑΝΑΡΑΣ)..... Ε2 = 10.79 (ΓΩΝΙΑ ΜΑΝΑΡΑΣ)..... Ε3 = 11.91 (ΓΩΝΙΑ ΜΑΝΑΡΑΣ).....</p>	 <p>ΚΑΡΦΙ K.54...</p> <p>Ε1 = 13.42 (ΓΩΝΙΑ ΜΑΝΑΡΑΣ)..... Ε2 = 11.84 (ΓΩΝΙΑ ΜΑΝΑΡΑΣ)..... Ε3 = 8.99 (ΓΩΝΙΑ ΜΑΝΑΡΑΣ).....</p>
 <p>ΚΑΡΦΙ K.55...</p> <p>ΔΕΝ ΕΞΑΣΦΑΛΙΖΕΤΑΙ</p> <p>Ε1 = Ε2 = Ε3 =</p>	 <p>ΚΑΡΦΙ K.56...</p> <p>ΔΕΝ ΕΞΑΣΦΑΛΙΖΕΤΑΙ</p> <p>Ε1 = Ε2 = Ε3 =</p>

ΕΞΑΣΦΑΛΙΣΕΙΣ ΚΟΡΥΦΩΝ

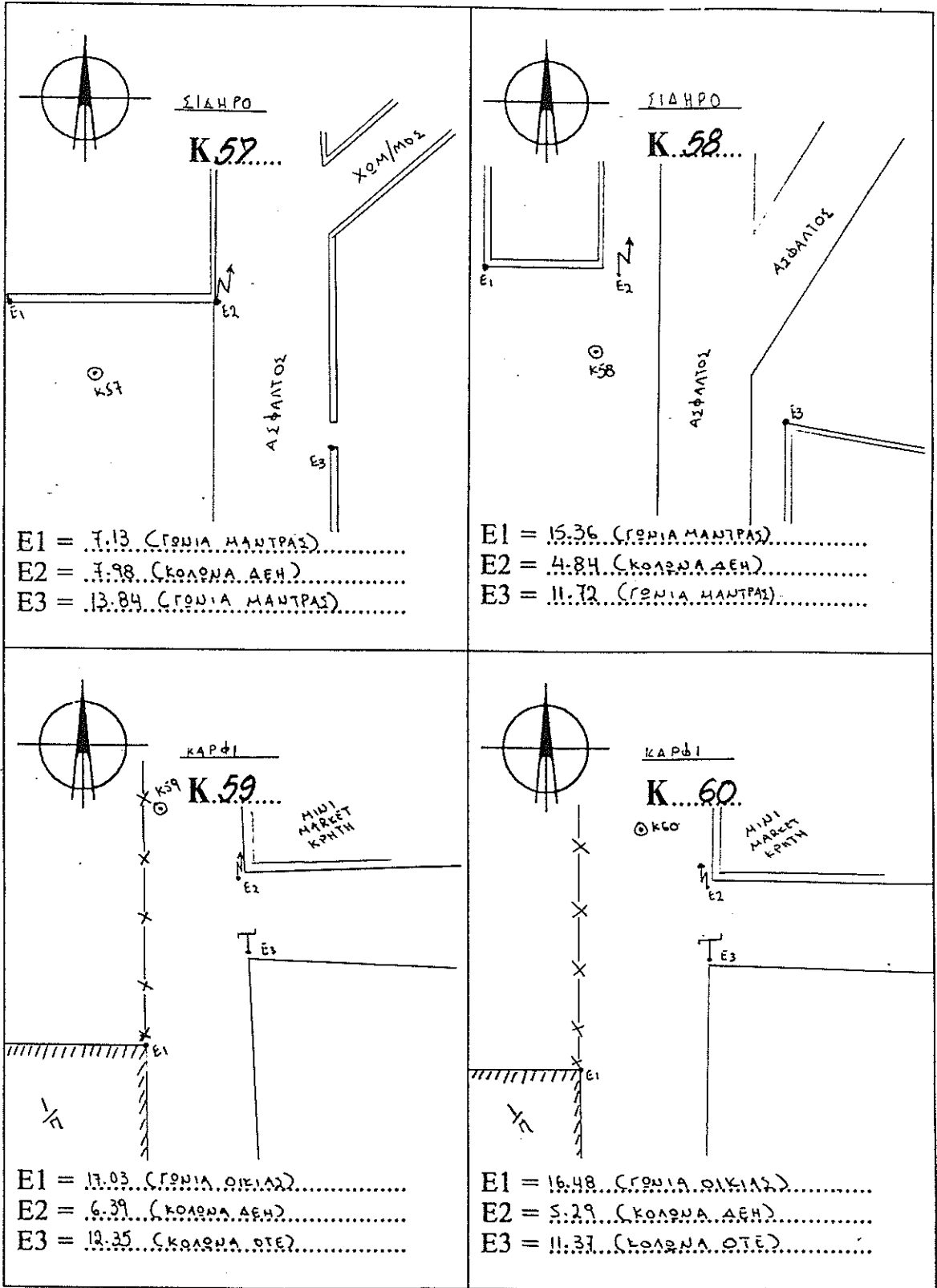

ΕΞΑΣΦΑΛΙΣΕΙΣ ΚΟΡΥΦΩΝ

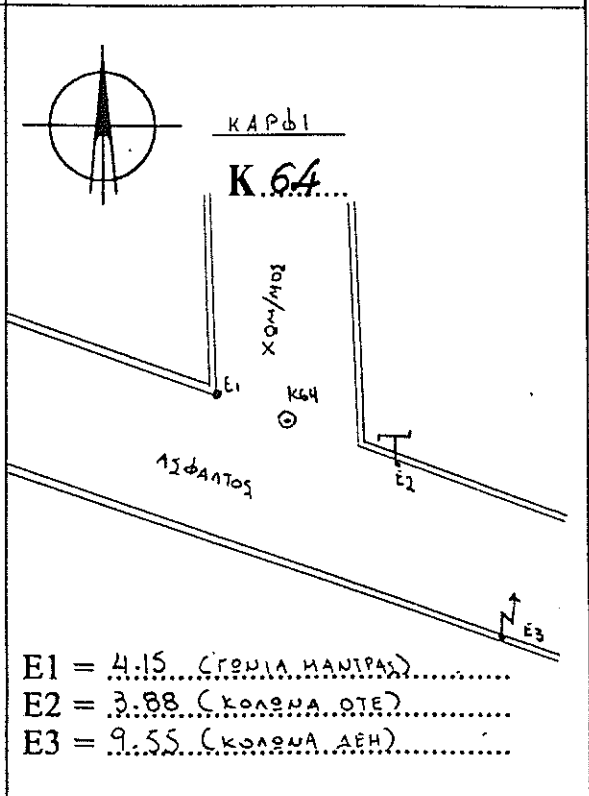
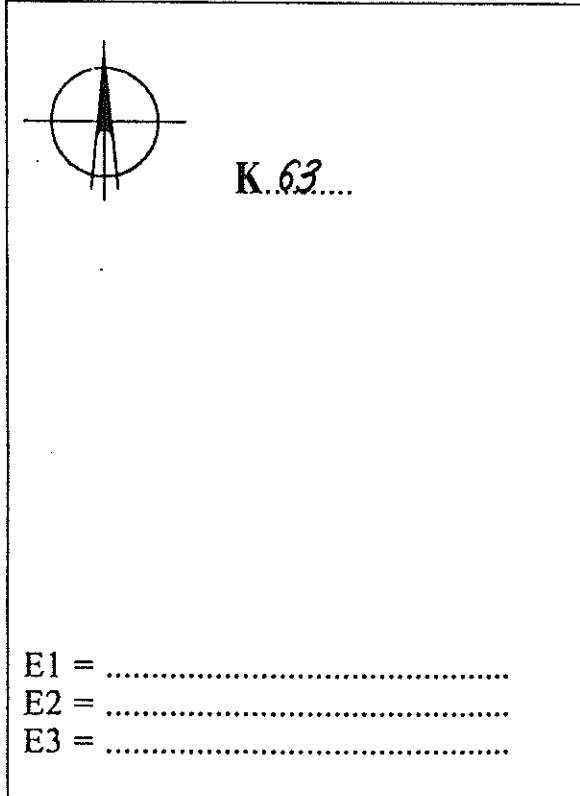
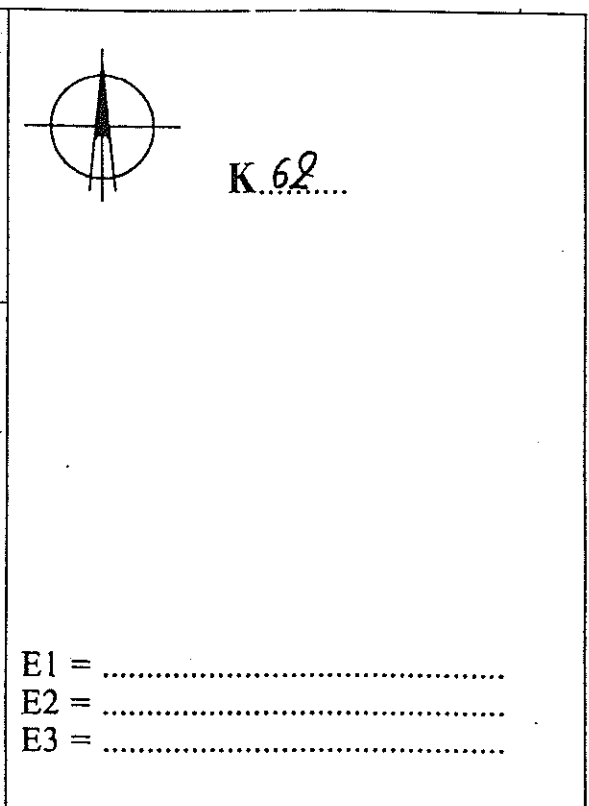
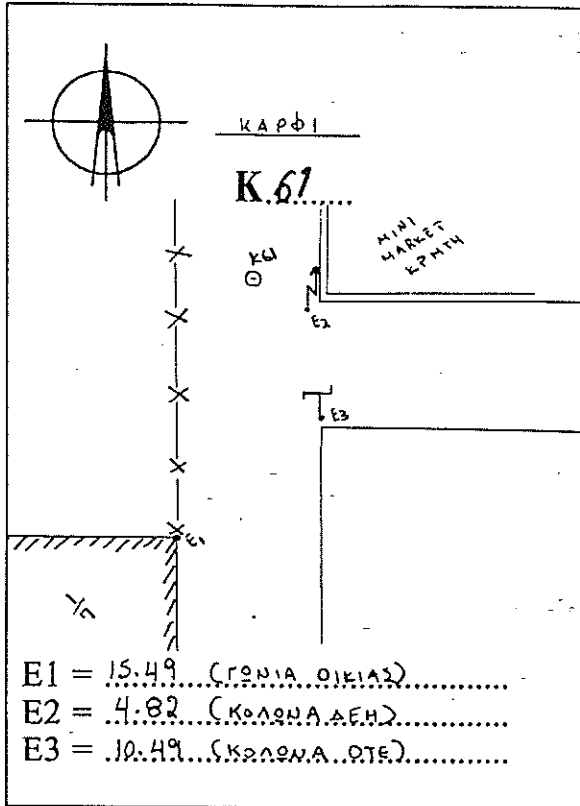

ΕΞΑΣΦΑΛΙΣΕΙΣ ΚΟΡΥΦΩΝ

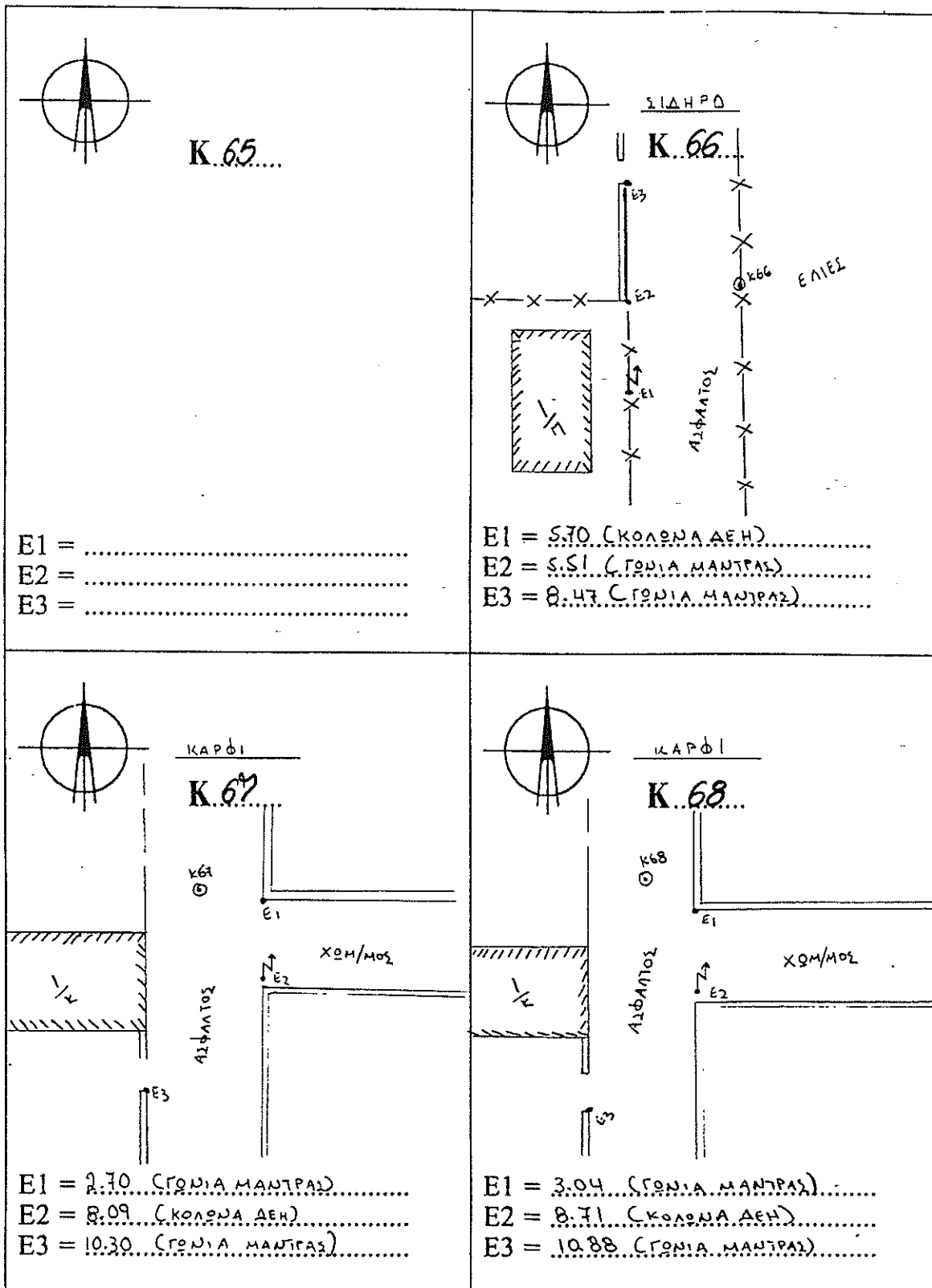

ΕΞΑΣΦΑΛΙΣΕΙΣ ΚΟΡΥΦΩΝ

<p>ΚΑΡΦΙ K.69</p> <p>Ε1 Ε2 Ε3</p> <p>Ε1 = 10.47 (ΓΟΝΙΑ ΜΑΝΤΡΑΣ) Ε2 = 3.13 (ΓΟΝΙΑ ΜΑΝΤΡΑΣ) Ε3 = 2.71 (ΓΟΝΙΑ ΜΑΝΤΡΑΣ)</p>	<p>ΣΙΔΗΡΟ K.70</p> <p>Ε1 Ε2 Ε3</p> <p>Ε1 = Ε2 = Ε3 =</p>
<p>ΚΑΡΦΙ K.71</p> <p>Ε1 Ε2 Ε3</p> <p>ΑΙΦΑΝΤΟΣ</p> <p>Ε1 = 12.81 (ΓΟΝΙΑ ΜΑΝΤΡΑΣ) Ε2 = 4.20 (ΓΟΝΙΑ ΜΑΝΤΡΑΣ) Ε3 = 3.45 (ΚΟΛΩΝΑ ΔΕΗ)</p>	<p>ΚΑΡΦΙ K.72</p> <p>ΔΕΝ ΕΞΑΣΦΑΛΙΖΕΤΑΙ</p> <p>Ε1 = Ε2 = Ε3 =</p>

ΕΞΑΣΦΑΛΙΣΕΙΣ ΚΟΡΥΦΩΝ

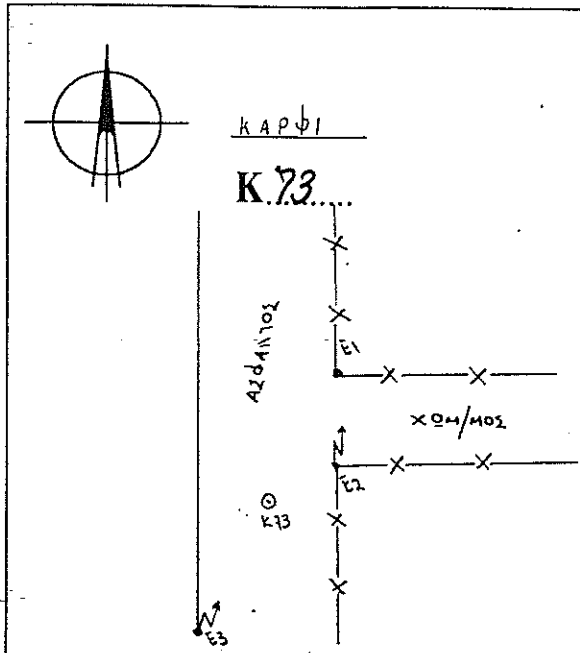

- E1 = 11.03 (ΣΙΑΗΡΟ ΠΑΣΣΑΛΟΣ).....
- E2 = 6.27 (ΚΟΛΩΝΑ ΔΕΗ).....
- E3 = 2.21 (ΚΟΛΩΝΑ ΔΕΗ).....

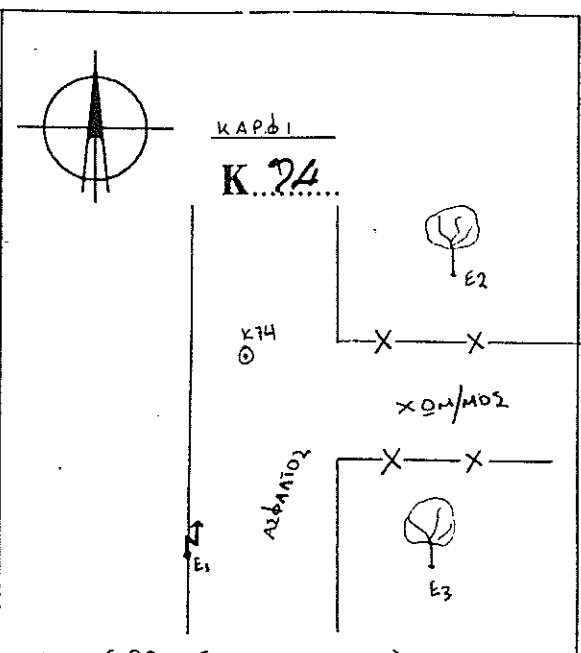

- E1 = 6.99 (ΚΟΛΩΝΑ ΔΕΗ).....
- E2 = 10.42 (ΑΜΥΓΑΛΙΑ).....
- E3 = 12.25 (ΕΛΙΑ).....

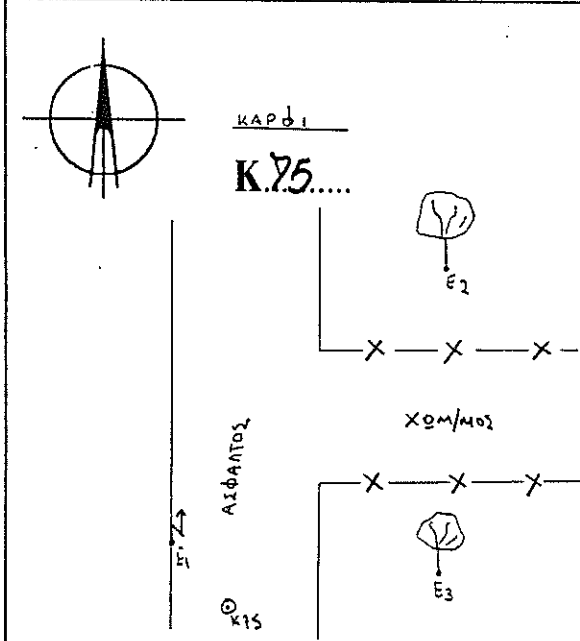

- E1 = 4.62 (ΚΟΛΩΝΑ ΔΕΗ).....
- E2 = 18.21 (ΑΜΥΓΑΛΙΑ).....
- E3 = 8.25 (ΕΛΙΑ).....

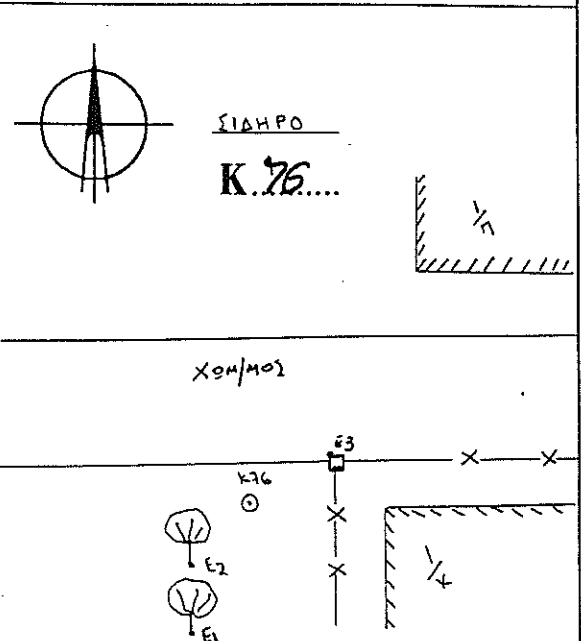

- E1 = 9.65 (ΔΕΝΤΡΟ).....
- E2 = 3.73 (ΔΕΝΤΡΟ).....
- E3 = 4.60 (ΚΟΛΩΝΑ).....

ΕΞΑΣΦΑΛΙΣΕΙΣ ΚΟΡΥΦΩΝ

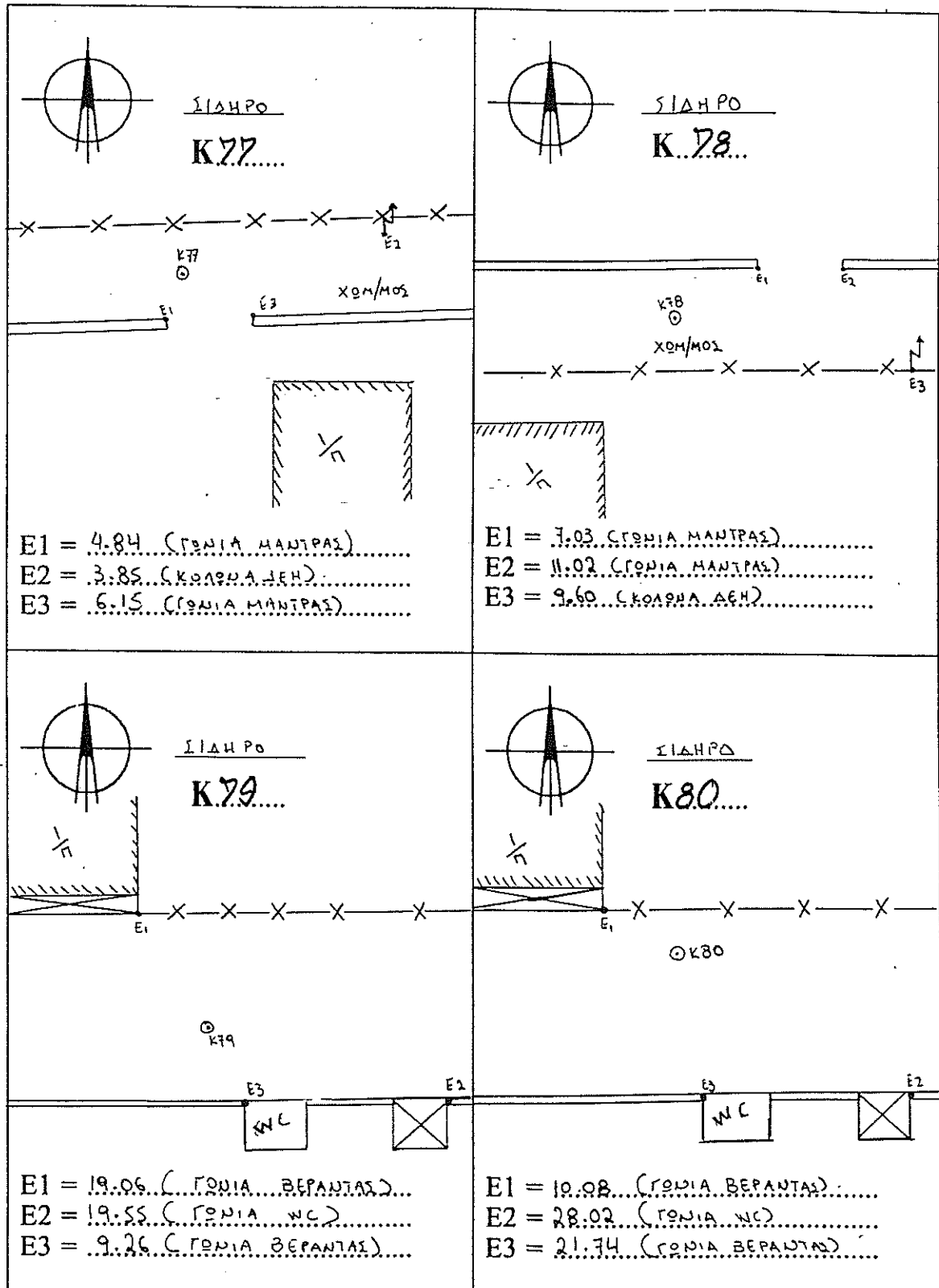

ΕΞΑΣΦΑΛΙΣΕΙΣ ΚΟΡΥΦΩΝ

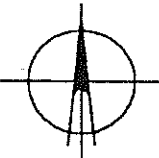
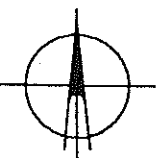
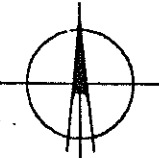
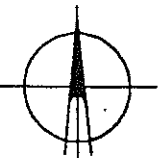
 <p>ΣΤΑΘΡΟ Κ81....</p> <p>ΔΕΥ ΕΞΑΣΦΑΛΙΣΕΙΣ</p> <p>E1 = E2 = E3 =</p>	 <p>Κ82....</p> <p>E1 = E2 = E3 =</p>
 <p>Κ83....</p> <p>E1 = E2 = E3 =</p>	 <p>Κ84....</p> <p>E1 = E2 = E3 =</p>

ΕΞΑΣΦΑΛΙΣΕΙΣ ΚΟΡΥΦΩΝ

<p>ΣΤΑΘΜΟ K85....</p> <p>Ε1 Ε2 Ε3</p> <p>ΧΩΜ/ΜΟΣ</p> <p>⊙ K85</p>	<p>ΣΤΑΘΜΟ K86....</p> <p>Ε1 Ε2</p> <p>ΧΩΜ/ΜΟΣ</p> <p>⊙ K86</p>
<p>E1 = 12.18 (ΚΟΛΩΝΑ ΟΤΕ).....</p> <p>E2 = 10.95 (ΓΩΝΙΑ ΜΑΝΤΡΑΣ).....</p> <p>E3 = 10.07 (ΚΟΛΩΝΑ ΔΕΗ).....</p>	<p>E1 = 18.72 (ΚΟΛΩΝΑ ΟΤΕ).....</p> <p>E2 = 5.30 (ΓΩΝΙΑ ΜΑΝΤΡΑΣ).....</p> <p>E3 = 3.55 (ΚΟΛΩΝΑ ΔΕΗ).....</p>
<p>ΣΤΑΘΜΟ K87....</p> <p>Ε1 Ε2</p> <p>ΧΩΜ/ΜΟΣ</p> <p>⊙ K87</p>	<p>ΣΤΑΘΜΟ K88....</p> <p>Ε1 Ε2 Ε3</p> <p>ΧΩΜ/ΜΟΣ</p> <p>⊙ K88</p>
<p>E1 = 21.96 (ΚΟΛΩΝΑ ΟΤΕ).....</p> <p>E2 = 4.05 (ΓΩΝΙΑ ΜΑΝΤΡΑΣ).....</p> <p>E3 = 1.36 (ΚΟΛΩΝΑ ΔΕΗ).....</p>	<p>E1 = 6.46 (ΓΩΝΙΑ ΜΑΝΤΡΑΣ).....</p> <p>E2 = 4.03 (ΓΩΝΙΑ ΜΑΝΤΡΑΣ).....</p> <p>E3 = 5.24 (ΓΩΝΙΑ ΜΑΝΤΡΑΣ).....</p>

ΕΞΑΣΦΑΛΙΣΕΙΣ ΚΟΡΥΦΩΝ

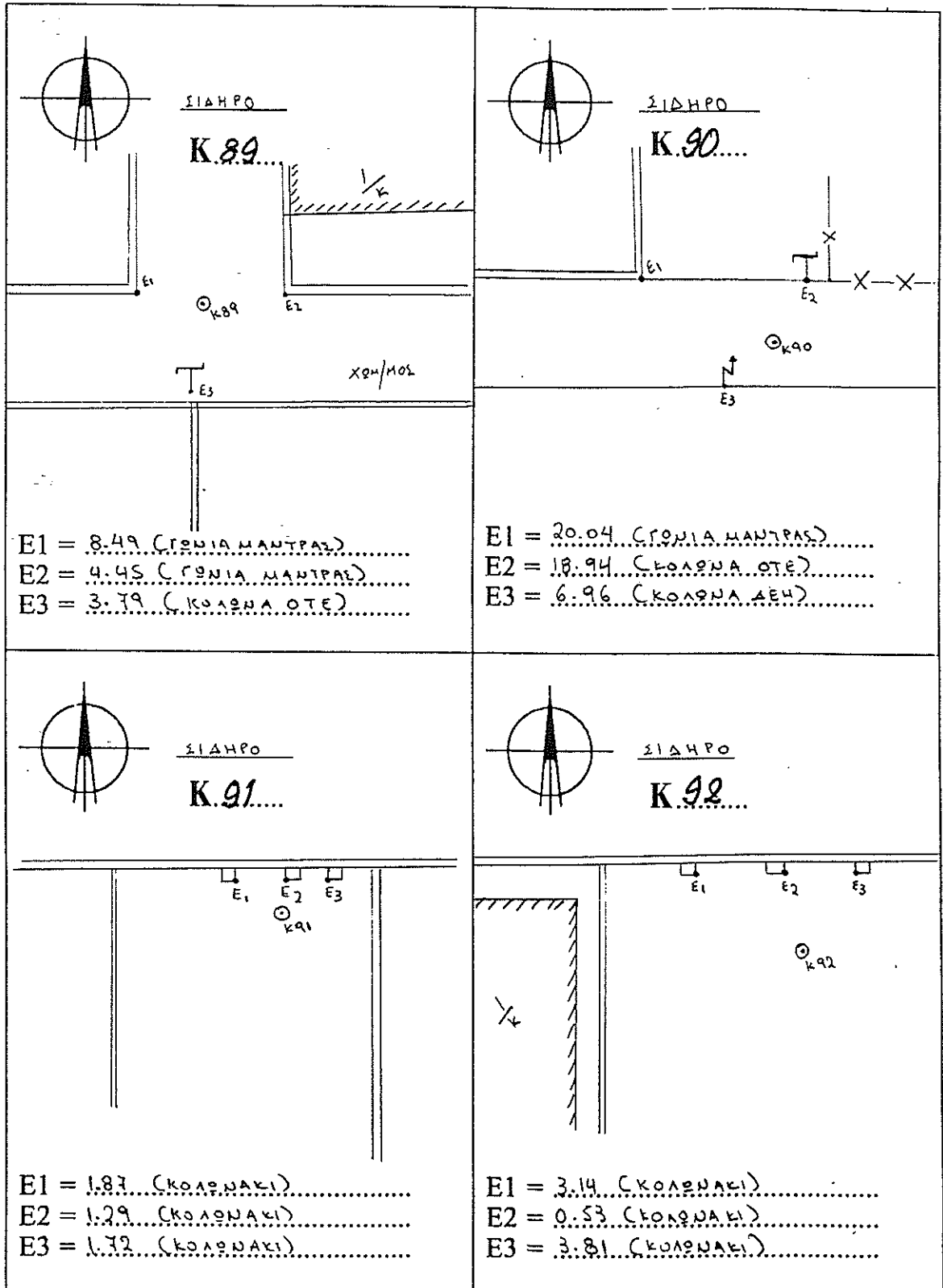

ΕΞΑΣΦΑΛΙΣΕΙΣ ΚΟΡΥΦΩΝ

<p>ΣΙΔΗΡΟ Κ.93...</p> <p>Ε2 Ε3</p> <p>ΧΩΜ/ΜΟΣ</p> <p>Ε1</p> <p>ΟΚ93</p>	<p>ΣΙΔΗΡΟ Κ.94...</p> <p>Ε1</p> <p>ΧΩΜ/ΜΟΣ</p> <p>Ε3</p> <p>ΟΚ94</p>
<p>Ε1 = 11.23 (ΓΩΝΙΑ ΜΑΝΤΡΑΣ).....</p> <p>Ε2 = 12.34 (ΓΩΝΙΑ ΜΑΝΤΡΑΣ).....</p> <p>Ε3 = 5.76 (ΓΩΝΙΑ ΜΑΝΤΡΑΣ).....</p>	<p>Ε1 = 7.46 (ΓΩΝΙΑ ΜΑΝΤΡΑΣ).....</p> <p>Ε2 = 8.90 (ΚΟΛΩΝΑ ΟΤΕ).....</p> <p>Ε3 = 9.37 (ΚΟΛΩΝΑ ΔΕΗ).....</p>
<p>ΣΙΔΗΡΟ Κ.95...</p> <p>Ε1</p> <p>ΧΩΜ/ΜΟΣ</p> <p>Ε2</p> <p>Ε3</p> <p>ΟΚ95</p>	<p>ΣΙΔΗΡΟ Κ.96...</p> <p>Ε1</p> <p>ΧΩΜ/ΜΟΣ</p> <p>Ε2</p> <p>Ε3</p> <p>ΟΚ96</p>
<p>Ε1 = 8.17 (ΓΩΝΙΑ ΜΑΝΤΡΑΣ).....</p> <p>Ε2 = 9.00 (ΚΟΛΩΝΑ ΟΤΕ).....</p> <p>Ε3 = 8.88 (ΚΟΛΩΝΑ ΔΕΗ).....</p>	<p>Ε1 = 7.71 (ΓΩΝΙΑ ΜΑΝΤΡΑΣ).....</p> <p>Ε2 = 8.62 (ΚΟΛΩΝΑ ΟΤΕ).....</p> <p>Ε3 = 9.12 (ΚΟΛΩΝΑ ΔΕΗ).....</p>

ΕΞΑΣΦΑΛΙΣΕΙΣ ΚΟΡΥΦΩΝ

<p>ΣΙΔΗΡΟ K.97</p> <p>E1 E2 E3</p> <p>⊙ K97 ΧΩΜ/ΜΟΣ</p> <p>E1 = 5.26 (ΓΩΝΙΑ ΜΑΝΤΡΑΣ)..... E2 = 3.44 (ΣΙΔΕΡΟ ΠΟΡΤΑΣ)..... E3 = 5.38 (ΣΙΔΕΡΟ ΠΟΡΤΑΣ).....</p>	<p>ΣΙΔΗΡΟ K.98</p> <p>E1 E2 E3</p> <p>⊙ K98 ΧΩΜ/ΜΟΣ</p> <p>E1 = 8.13 (ΣΙΔΗΡΟΠΑΣΣΑΛΟΣ)..... E2 = 2.57 (ΣΙΔΗΡΟΠΑΣΣΑΛΟΣ)..... E3 = 3.50 (ΣΙΔΗΡΟΠΑΣΣΑΛΟΣ).....</p>
<p>ΣΙΔΗΡΟ K.99</p> <p>E1 E2 E3</p> <p>⊙ K99 ΧΩΜ/ΜΟΣ</p> <p>E1 = 5.12 (ΓΩΝΙΑ ΜΑΝΤΡΑΣ)..... E2 = 3.80 (ΓΩΝΙΑ ΜΑΝΤΡΑΣ)..... E3 = 3.50 (ΓΩΝΙΑ ΜΑΝΤΡΑΣ).....</p>	<p>ΣΙΔΗΡΟ K.100</p> <p>E1 E2 E3</p> <p>⊙ K100 ΧΩΜ/ΜΟΣ</p> <p>E1 = 13.83 (ΓΩΝΙΑ ΜΑΝΤΡΑΣ)..... E2 = 3.79 (ΓΩΝΙΑ ΜΑΝΤΡΑΣ)..... E3 = 5.75 (ΓΩΝΙΑ ΜΑΝΤΡΑΣ).....</p>

201354.69
456488.72

349.24
533.04

ΕΞΑΣΦΑΛΙΣΕΙΣ ΚΟΡΥΦΩΝ

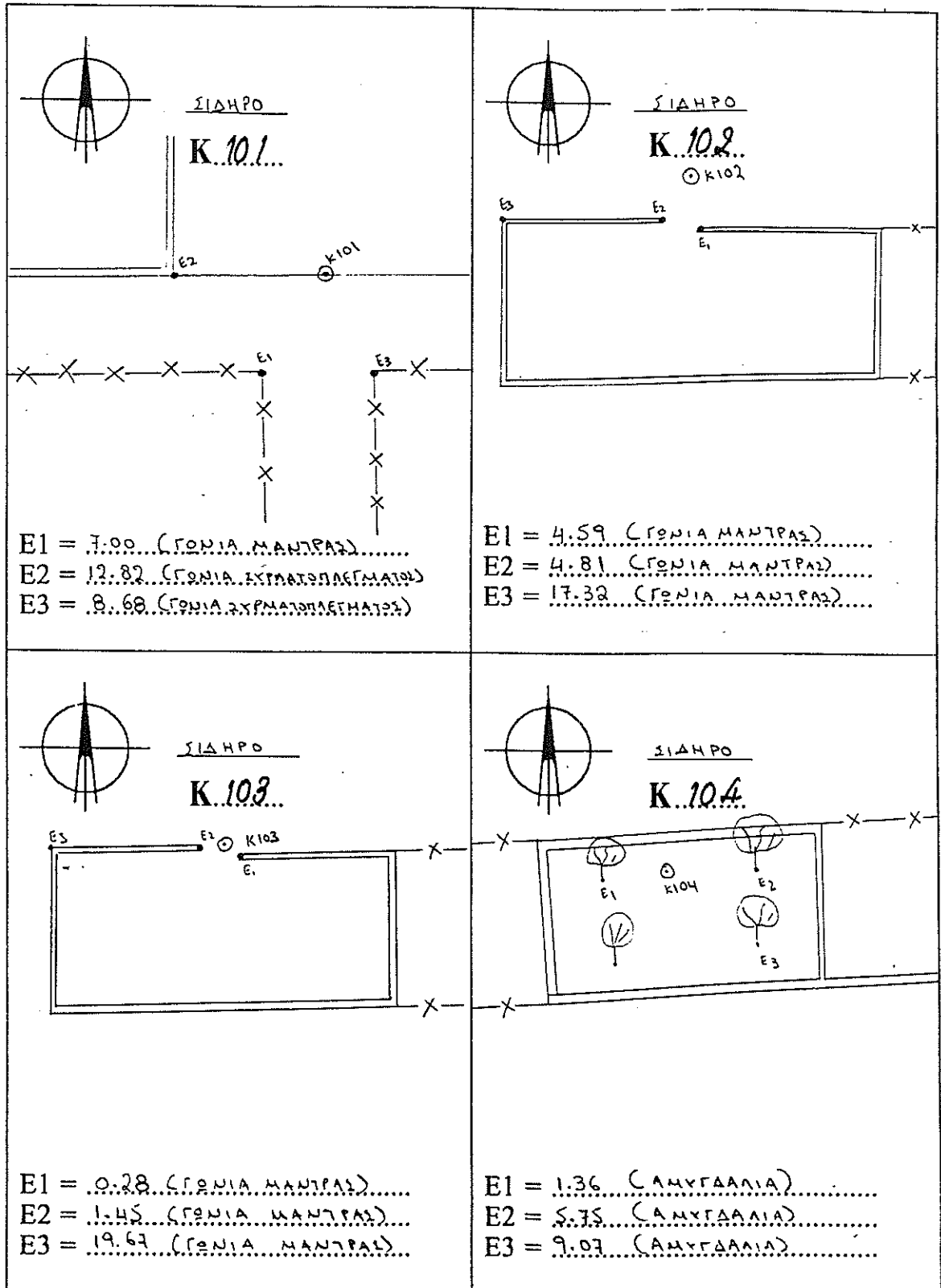

ΕΞΑΣΦΑΛΙΣΕΙΣ ΚΟΡΥΦΩΝ

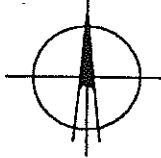
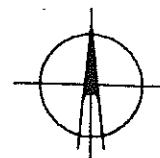
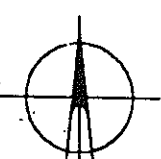
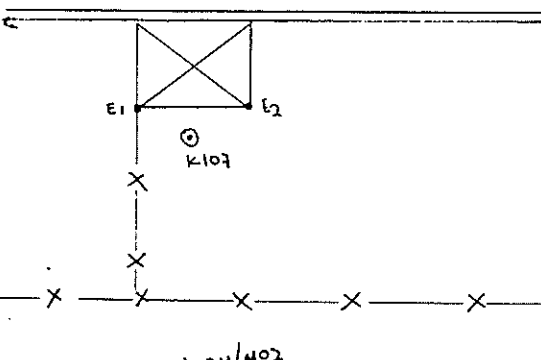
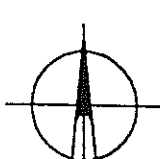
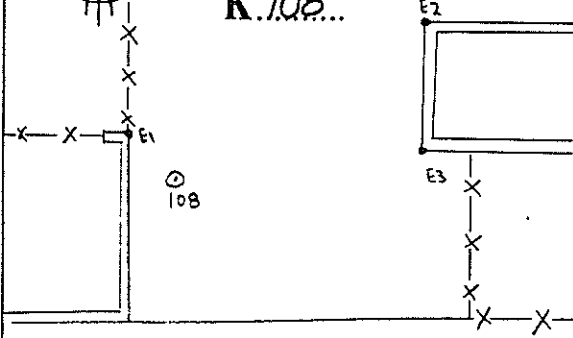
<div style="text-align: center;">  <p>K.105...</p> </div> <p>E1 =</p> <p>E2 =</p> <p>E3 =</p>	<div style="text-align: center;">  <p>K.106..</p> </div> <p>E1 =</p> <p>E2 =</p> <p>E3 =</p>
<div style="text-align: center;">  <p><u>ΣΙΔΗΡΟ</u> K.107...</p> </div>  <p style="text-align: center;">Xcm/mos</p> <p>E1 = 1.89 (ΓΟΝΙΑ ΒΕΡΑΝΤΑΣ)</p> <p>E2 = 0.71 (ΓΟΝΙΑ ΒΕΡΑΝΤΑΣ)</p> <p>E3 = ΔΕΝ ΕΞΑΣΦΑΛΙΖΕΤΑΙ</p>	<div style="text-align: center;">  <p><u>ΣΙΔΗΡΟ</u> K.108...</p> </div>  <p style="text-align: center;">Xcm/mos</p> <p>E1 = 3.60 (ΓΟΝΙΑ ΜΑΝΤΡΑΣ)</p> <p>E2 = 19.28 (ΓΟΝΙΑ ΜΑΝΤΡΑΣ)</p> <p>E3 = 14.68 (ΓΟΝΙΑ ΜΑΝΤΡΑΣ)</p>

ΕΞΑΣΦΑΛΙΣΕΙΣ ΚΟΡΥΦΩΝ

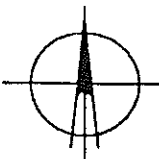
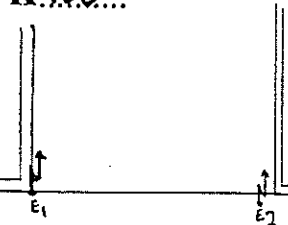
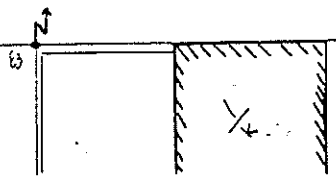
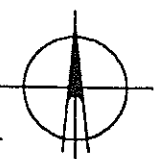
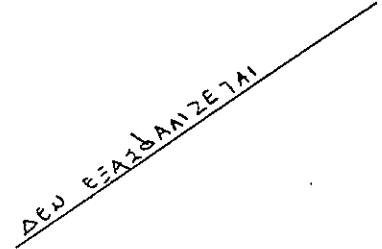
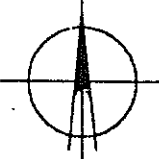
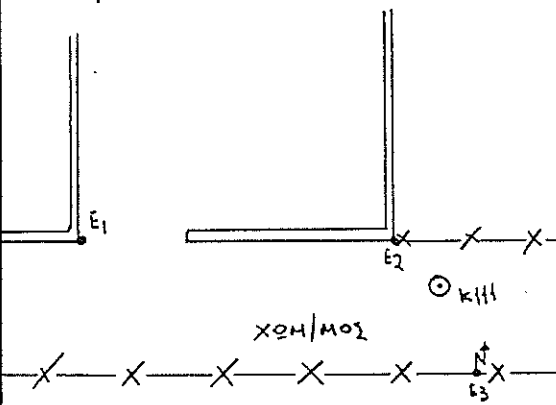
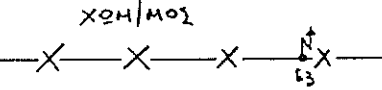
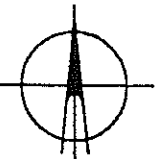
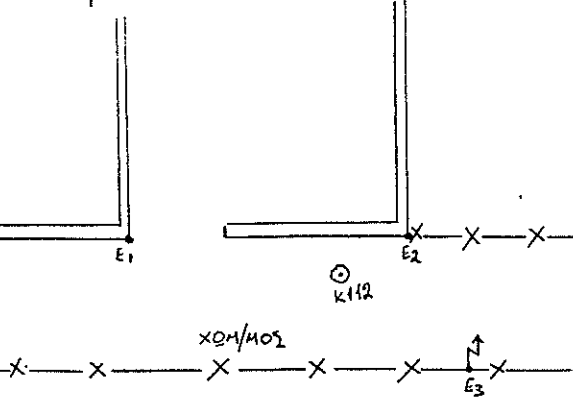
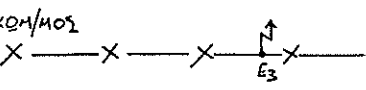
<p>  <u>ΣΤΑΘΜΟ</u> K.109... </p>  <p>  ΘΚΙΟ9 </p> <p> E1 = 17.56 (ΚΟΛΩΝΑ ΔΕΗ) E2 = 14.90 (ΚΟΛΩΝΑ ΔΕΗ) E3 = 4.22 (ΚΟΛΩΝΑ ΔΕΗ) </p>	<p>  K.110... </p> <p>  </p> <p> E1 = E2 = E3 = </p>
<p>  <u>ΣΤΑΘΜΟ</u> K.111... </p>  <p>  ΧΟΗ/ΜΟΣ ΘΚΙ11 </p> <p> E1 = 12.05 (ΓΩΝΙΑ ΜΑΝΤΡΑΣ) E2 = 1.51 (ΓΩΝΙΑ ΜΑΝΤΡΑΣ) E3 = 4.66 (ΚΟΛΩΝΑ ΔΕΗ) </p>	<p>  <u>ΣΤΑΘΜΟ</u> K.112... </p>  <p>  ΧΟΗ/ΜΟΣ ΘΚΙ12 </p> <p> E1 = 9.09 (ΓΩΝΙΑ ΜΑΝΤΡΑΣ) E2 = 2.43 (ΓΩΝΙΑ ΜΑΝΤΡΑΣ) E3 = 5.53 (ΚΟΛΩΝΑ ΔΕΗ) </p>

ΕΞΑΣΦΑΛΙΣΕΙΣ ΚΟΡΥΦΩΝ

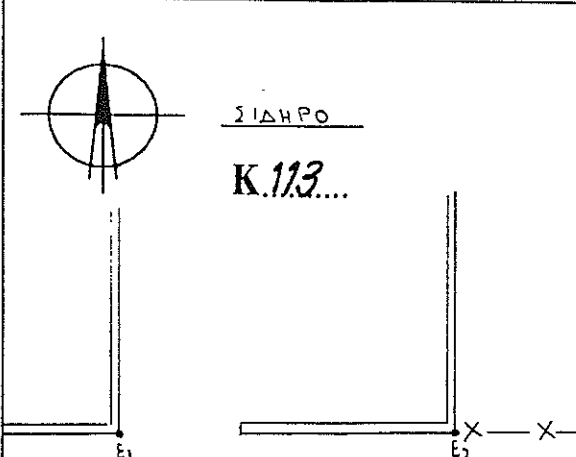
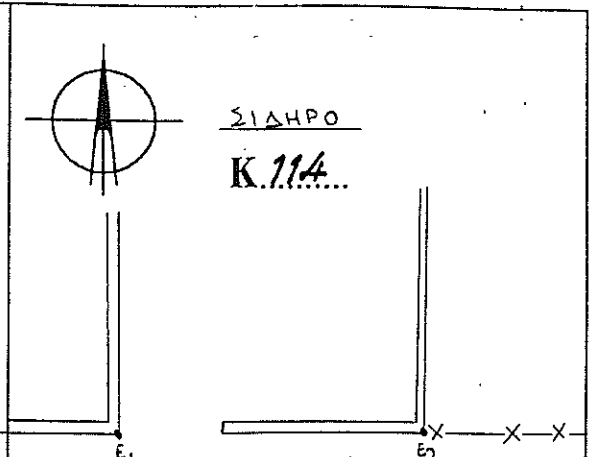
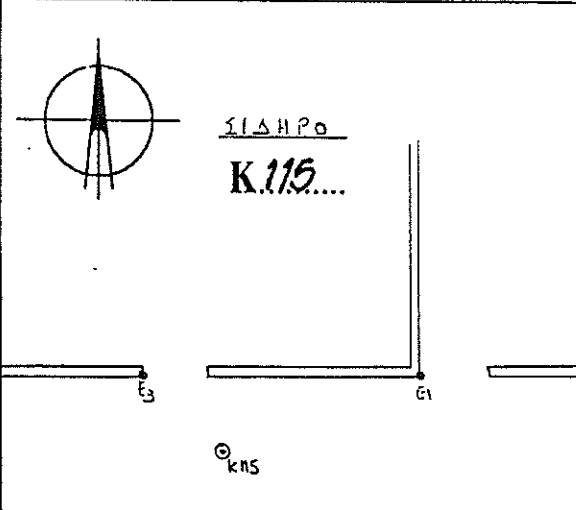
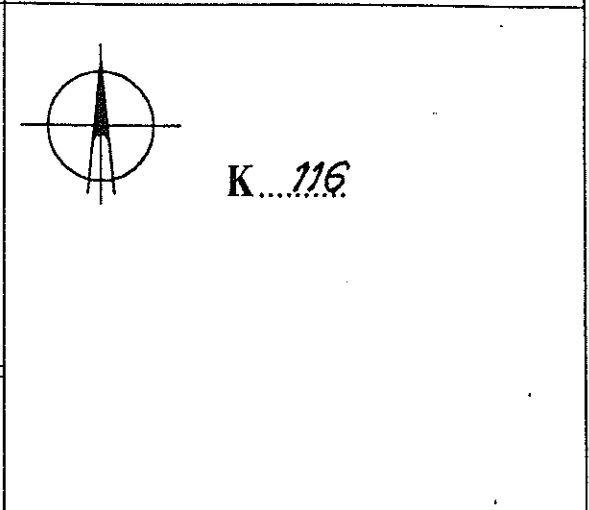
 <p>ΣΙΔΗΡΟ Κ.113...</p> <p>⊙ κ113 ΧΩΜ/ΜΟΣ</p> <p>E1 = 2.64 (ΓΩΝΙΑ ΜΑΝΤΡΑΣ)..... E2 = 8.86 (ΓΩΝΙΑ ΜΑΝΤΡΑΣ)..... E3 = 10.75 (ΚΟΛΩΝΑ ΔΕΗ).....</p>	 <p>ΣΙΔΗΡΟ Κ.114...</p> <p>⊙ κ114 ΧΩΜ/ΜΟΣ</p> <p>E1 = 1.93 (ΓΩΝΙΑ ΜΑΝΤΡΑΣ)..... E2 = 9.71 (ΓΩΝΙΑ ΜΑΝΤΡΑΣ)..... E3 = 11.50 (ΚΟΛΩΝΑ ΔΕΗ).....</p>
 <p>ΣΙΔΗΡΟ Κ.115...</p> <p>⊙ κ115</p> <p>E1 = 9.10 (ΓΩΝΙΑ ΜΑΝΤΡΑΣ)..... E2 = 10.70 (ΓΩΝΙΑ ΜΑΝΤΡΑΣ)..... E3 = 4.86 (ΓΩΝΙΑ ΜΑΝΤΡΑΣ).....</p>	 <p>Κ.116</p> <p>E1 = E2 = E3 =</p>

ΕΞΑΣΦΑΛΙΣΕΙΣ ΚΟΡΥΦΩΝ

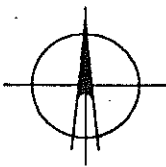
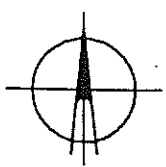
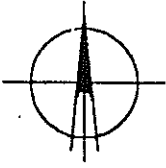
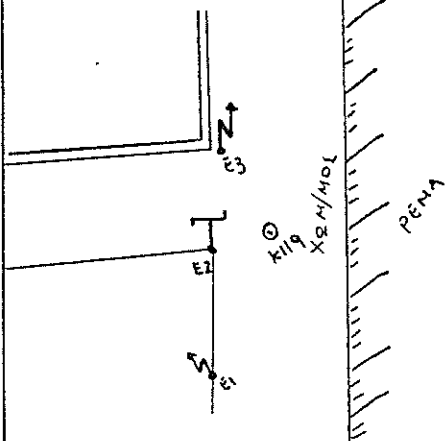
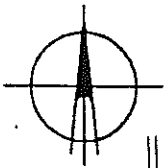
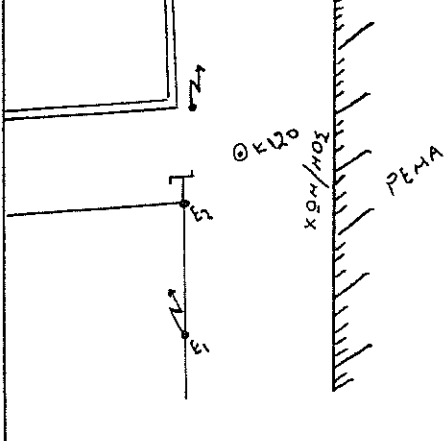
<div style="text-align: center;">  </div> <p style="text-align: center; font-weight: bold;">Κ.117...</p> <p>E1 =</p> <p>E2 =</p> <p>E3 =</p>	<div style="text-align: center;">  </div> <p style="text-align: center; font-weight: bold;">Κ.118...</p> <p>E1 =</p> <p>E2 =</p> <p>E3 =</p>
<div style="text-align: center;">  </div> <p style="text-align: center;">ΣΙΔΗΡΟ</p> <p style="text-align: center; font-weight: bold;">Κ.119...</p>  <p>E1 =</p> <p>E2 =</p> <p>E3 =</p>	<div style="text-align: center;">  </div> <p style="text-align: center;">ΣΙΔΗΡΟ</p> <p style="text-align: center; font-weight: bold;">Κ.120...</p>  <p>E1 =</p> <p>E2 =</p> <p>E3 =</p>

ΕΞΑΣΦΑΛΙΣΕΙΣ ΚΟΡΥΦΩΝ

K.121 (σίδερο)

πέφυμα

E1 = 9.42 (γωνία ορθογωνίου τριγώνου)
 E2 = 14.17
 E3 = 12.40 (πλευρά)

K.122 (σίδερο)

πέφυμα

E1 = 11.26 (γωνία ορθογωνίου τριγώνου)
 E2 = 15.26
 E3 = 10.50 (πλευρά)

K.123...

ΔΕΝ ΤΟΠΟΘΕΤΕΙΤΑΙ

E1 =
 E2 =
 E3 =

ΣΙΔΗΡΟ
K.124

E1 = 3.18 (ΓΩΝΙΑ ΟΙΚΙΑΣ)
 E2 = 1.99 (ΕΛΛΙΑ)
 E3 = 4.78 (ΓΩΝΙΑ ΟΙΚΙΑΣ)

ΕΞΑΣΦΑΛΙΣΕΙΣ ΚΟΡΥΦΩΝ

ΣΙΑΗΡΟ
K 125

E1
E2
E3

E1 = 6.15 (ΓΩΝΙΑ ΟΙΚΙΑΣ)
E2 = 11.98 (ΕΛΙΑ)
E3 = 7.18 (ΓΩΝΙΑ ΜΑΝΤΡΑΣ)

ΣΙΑΗΡΟ
K 126

E1
E2
E3

E1 = 6.50 (ΓΩΝΙΑ ΟΙΚΙΑΣ)
E2 = 11.28 (ΕΛΙΑ)
E3 = 4.56 (ΓΩΝΙΑ ΜΑΝΤΡΑΣ)

ΣΙΑΗΡΟ
K 127

E1
E2
E3

E1 = 7.63 (ΓΩΝΙΑ ΟΙΚΙΑΣ)
E2 = 11.36 (ΕΛΙΑ)
E3 = 3.35 (ΓΩΝΙΑ ΜΑΝΤΡΑΣ)

K 128

Σε εφευρεθεί

E1 =
E2 =
E3 =

ΕΞΑΣΦΑΛΙΣΕΙΣ ΚΟΡΥΦΩΝ

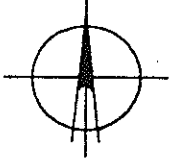
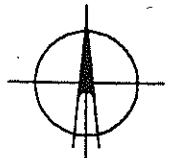
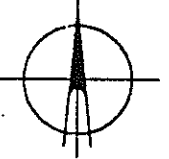
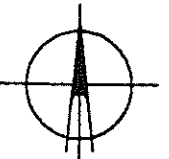
 <p>Κ. 129</p> <p>E1 = E2 = E3 =</p>	 <p>Κ. 130</p> <p><i>δεν εξασφαλίεται</i></p> <p>E1 = E2 = E3 =</p>
 <p>Κ. 131</p> <p><i>δεν εξασφαλίεται</i></p> <p>E1 = E2 = E3 =</p>	 <p>Κ. 132</p> <p><i>δεν εξασφαλίεται</i></p> <p>E1 = E2 = E3 =</p>

ΕΞΑΣΦΑΛΙΣΕΙΣ ΚΟΡΥΦΩΝ

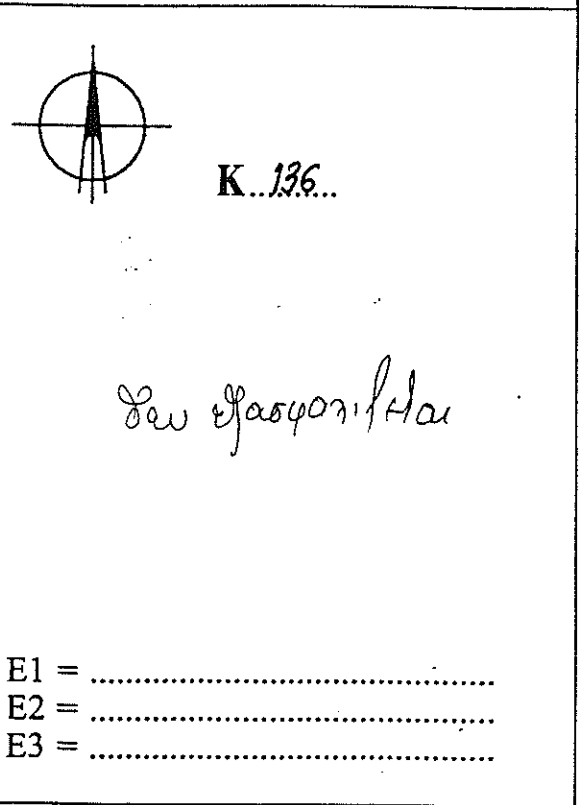
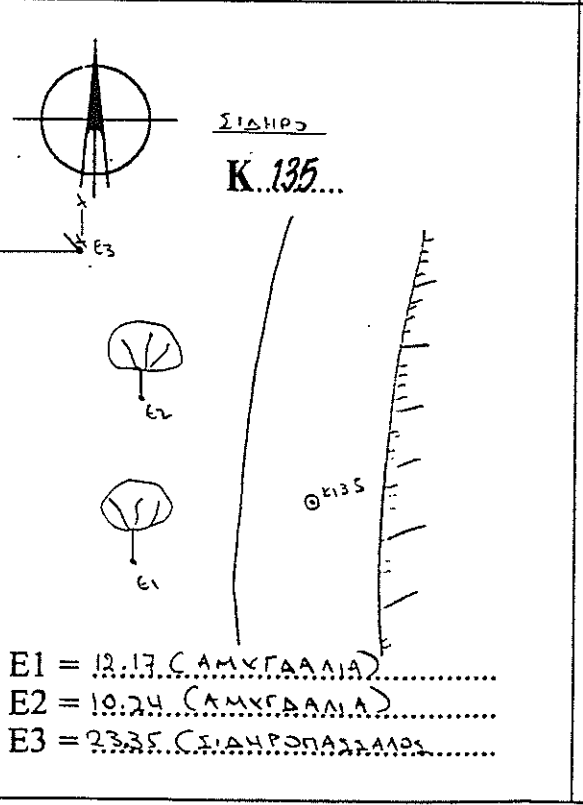
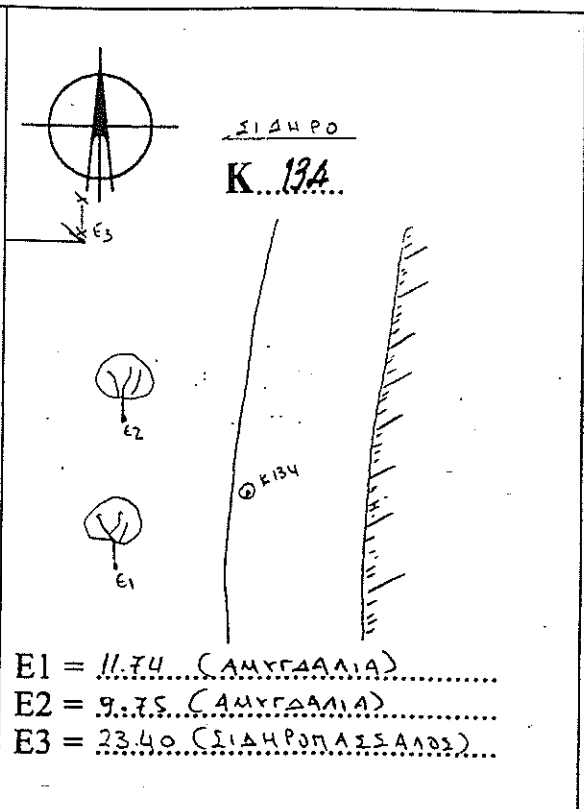
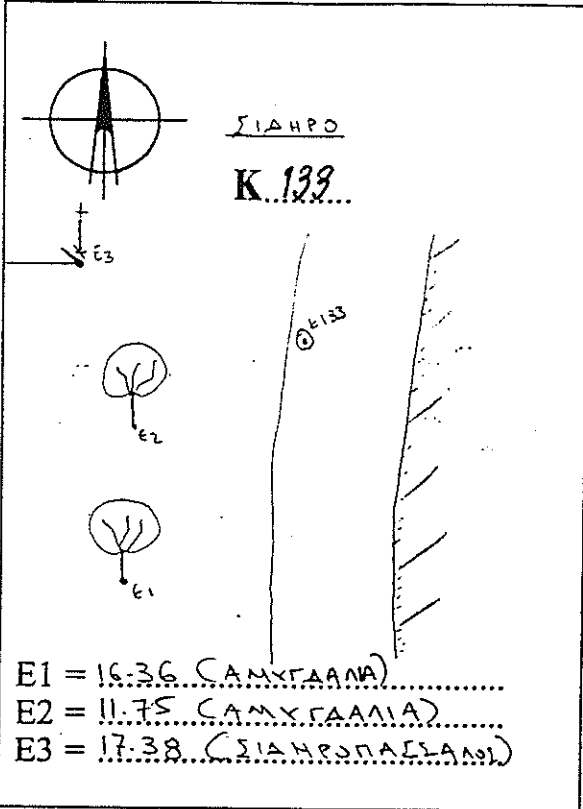

ΕΞΑΣΦΑΛΙΣΕΙΣ ΚΟΡΥΦΩΝ

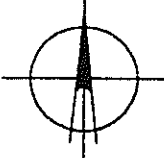
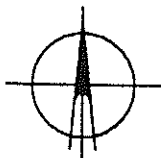
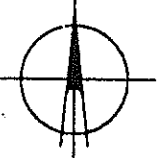
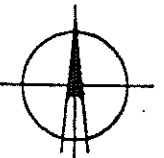
 <p>K.137...</p> <p><i>δεν εξασφαλίσει</i></p> <p>E1 = E2 = E3 =</p>	 <p>K.138...</p> <p><i>δεν εξασφαλίσει</i></p> <p>E1 = E2 = E3 =</p>
 <p>K.139...</p> <p><i>δεν εξασφαλίσει</i></p> <p>E1 = E2 = E3 =</p>	 <p>K.140...</p> <p><i>δεν εξασφαλίσει</i></p> <p>E1 = E2 = E3 =</p>

ΕΞΑΣΦΑΛΙΣΕΙΣ ΚΟΡΥΦΩΝ

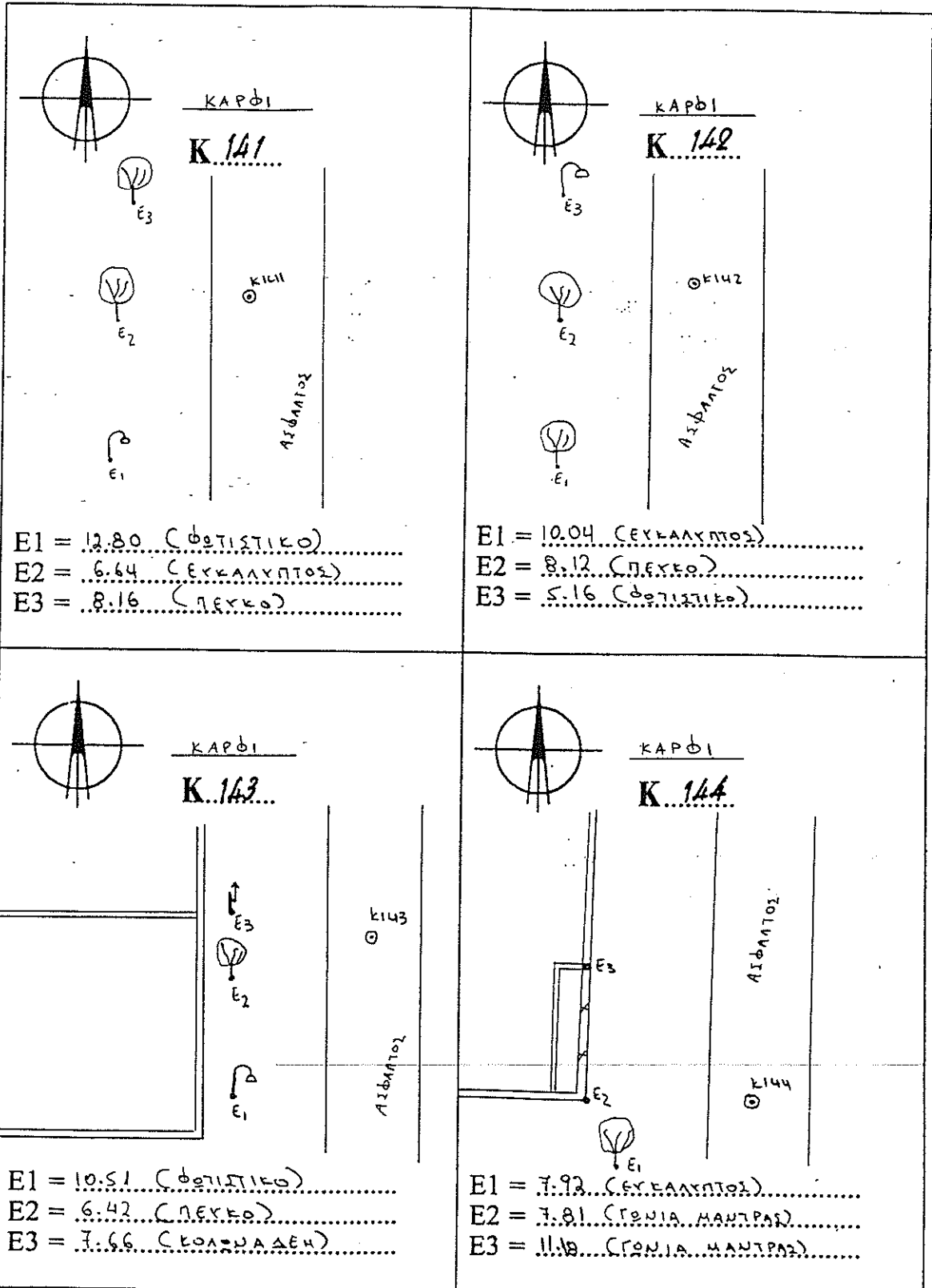

ΕΞΑΣΦΑΛΙΣΕΙΣ ΚΟΡΥΦΩΝ

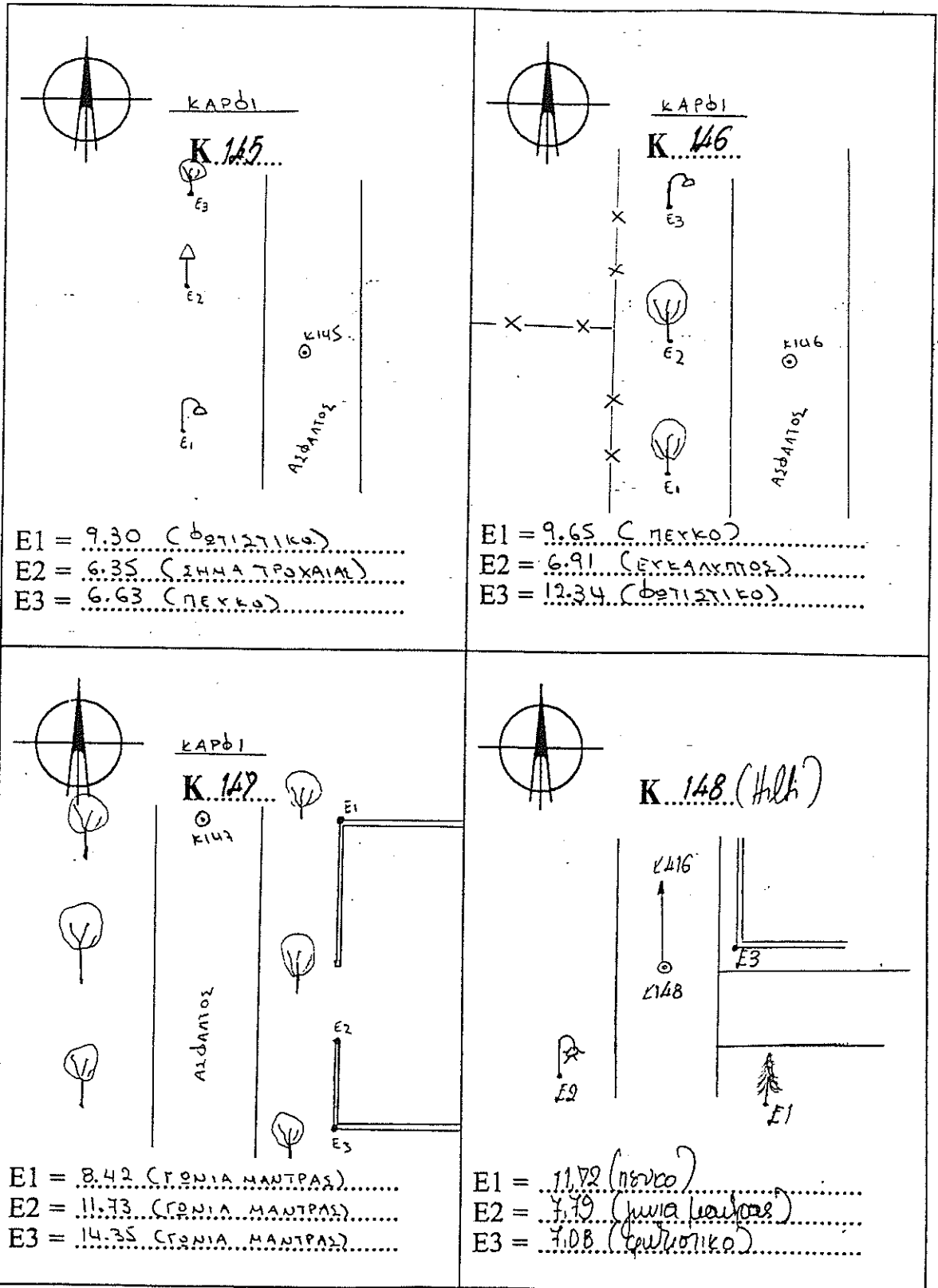

ΕΞΑΣΦΑΛΙΣΕΙΣ ΚΟΡΥΦΩΝ

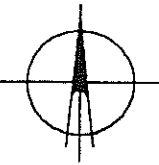
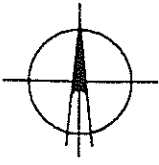
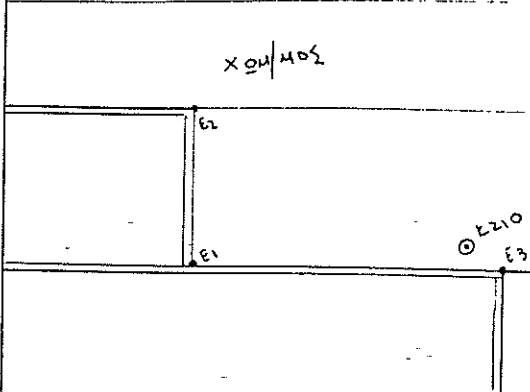
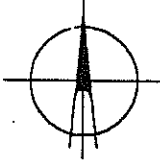
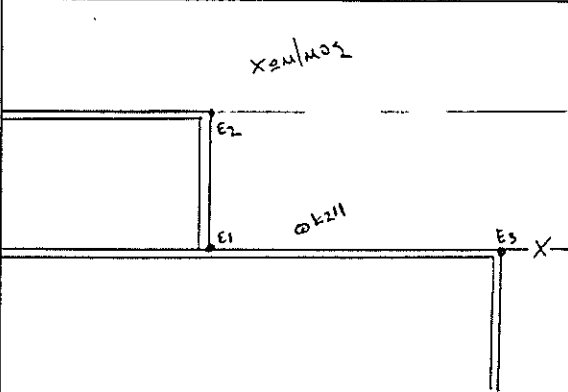
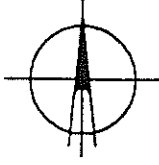
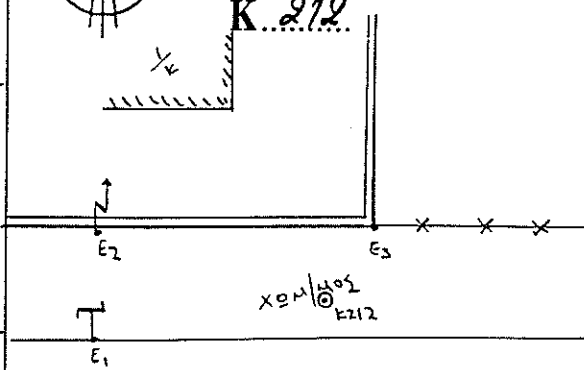
 <p>K.209</p> <p>ΑΕΥ ΕΞΑΣΦΑΛΙΖΕΤΑΙ</p> <p>E1 = E2 = E3 =</p>	 <p>ΣΙΔΗΡΟ</p> <p>K.210</p> <p>ΧΩΜ/ΜΟΣ</p>  <p>E1 = 21.97 (ΓΩΝΙΑ ΜΑΝΤΡΑΣ) E2 = 28.12 (ΓΩΝΙΑ ΜΑΝΤΡΑΣ) E3 = 0.61 (ΓΩΝΙΑ ΜΑΝΤΡΑΣ)</p>
 <p>ΣΙΔΗΡΟ</p> <p>K.211</p> <p>ΧΩΜ/ΜΟΣ</p>  <p>E1 = 10.90 (ΓΩΝΙΑ ΜΑΝΤΡΑΣ) E2 = 21.38 (ΓΩΝΙΑ ΜΑΝΤΡΑΣ) E3 = 11.46 (ΓΩΝΙΑ ΜΑΝΤΡΑΣ)</p>	 <p>ΣΙΔΗΡΟ</p> <p>K.212</p> <p>ΧΩΜ/ΜΟΣ</p>  <p>E1 = 6.37 (ΚΟΛΩΝΑ ΟΤΕ) E2 = 11.32 (ΚΟΛΩΝΑ ΔΕΗ) E3 = 6.37 (ΓΩΝΙΑ ΜΑΝΤΡΑΣ)</p>

ΕΞΑΣΦΑΛΙΣΕΙΣ ΚΟΡΥΦΩΝ

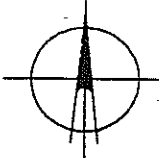
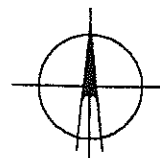
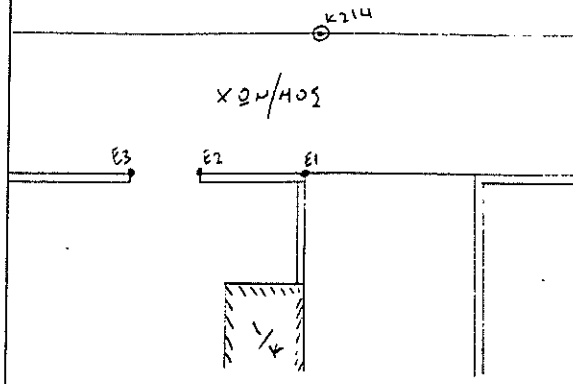
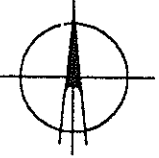
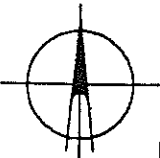
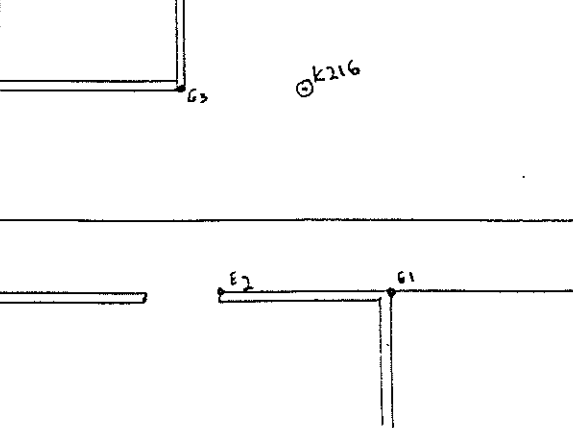
<div style="text-align: center;">  <p>ΣΤΑΘΜΟ K.213</p> </div> <p style="text-align: center; transform: rotate(-45deg);">ΔΕΝ ΕΞΑΣΦΑΛΙΖΕΤΑΙ</p> <p>E1 =</p> <p>E2 =</p> <p>E3 =</p>	<div style="text-align: center;">  <p>ΣΤΑΘΜΟ K.214</p> </div> <p style="text-align: right;">K214</p> <p style="text-align: center;">ΧΩΜ/ΜΟΣ</p>  <p>E1 = 11.76 (ΓΟΝΙΑ ΜΑΝΤΡΑΣ).....</p> <p>E2 = 14.88 (ΓΟΝΙΑ ΜΑΝΤΡΑΣ).....</p> <p>E3 = 19.42 (ΓΟΝΙΑ ΜΑΝΤΡΑΣ).....</p>
<div style="text-align: center;">  <p>ΣΤΑΘΜΟ K.215</p> </div> <p style="text-align: center; transform: rotate(-45deg);">ΔΕΝ ΕΞΑΣΦΑΛΙΖΕΤΑΙ</p> <p>E1 =</p> <p>E2 =</p> <p>E3 =</p>	<div style="text-align: center;">  <p>ΣΤΑΘΜΟ K.216</p> </div> <p style="text-align: right;">K216</p>  <p>E1 = 21.52 (ΓΟΝΙΑ ΜΑΝΤΡΑΣ).....</p> <p>E2 = 21.40 (ΓΟΝΙΑ ΜΑΝΤΡΑΣ).....</p> <p>E3 = 11.14 (ΓΟΝΙΑ ΜΑΝΤΡΑΣ).....</p>

ΕΞΑΣΦΑΛΙΣΕΙΣ ΚΟΡΥΦΩΝ

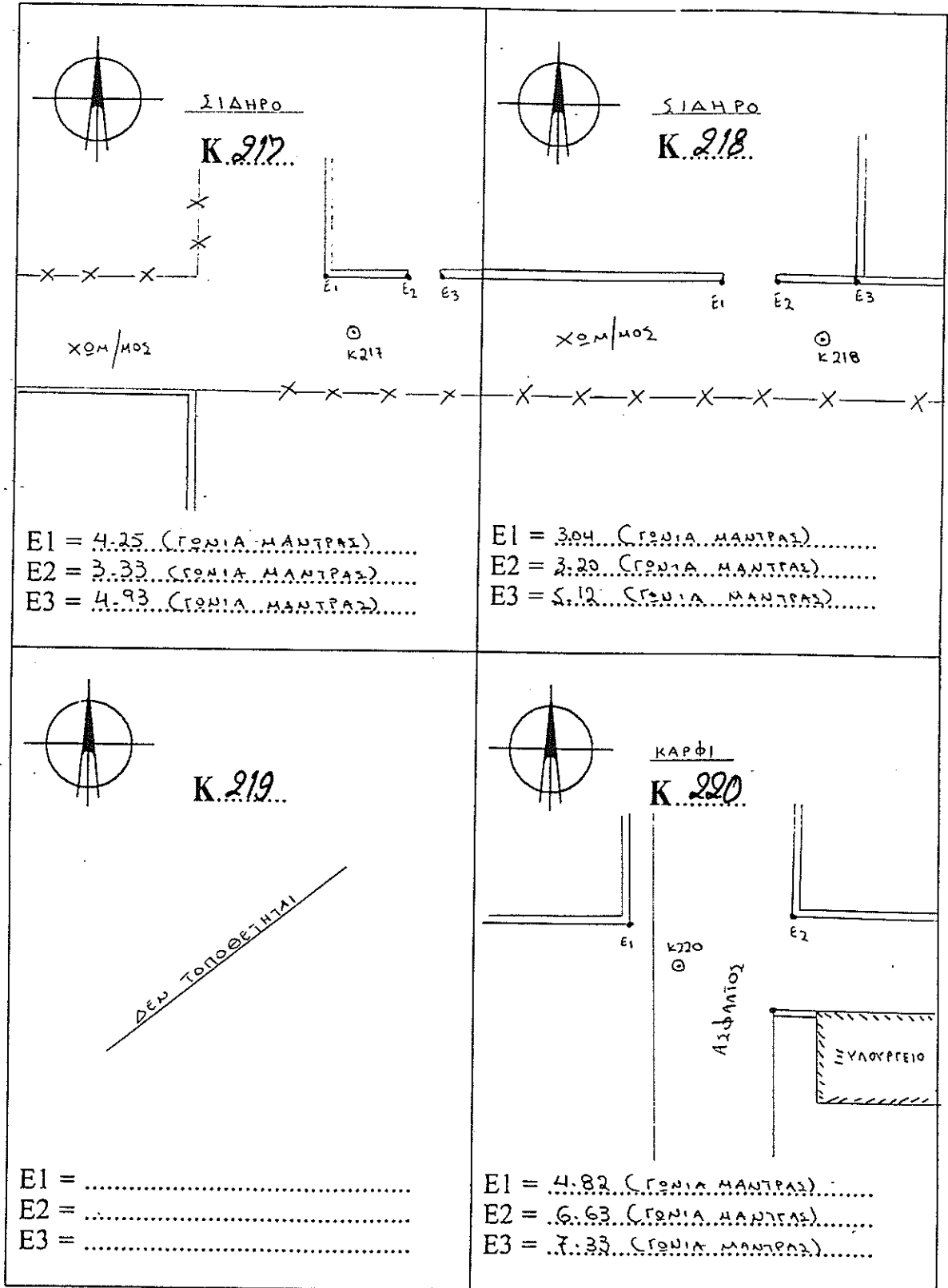

ΕΞΑΣΦΑΛΙΣΕΙΣ ΚΟΡΥΦΩΝ

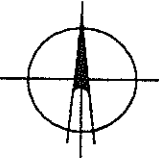
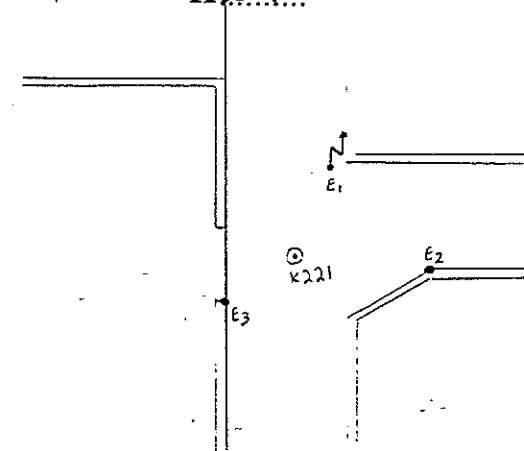
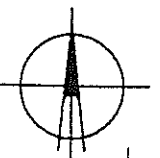
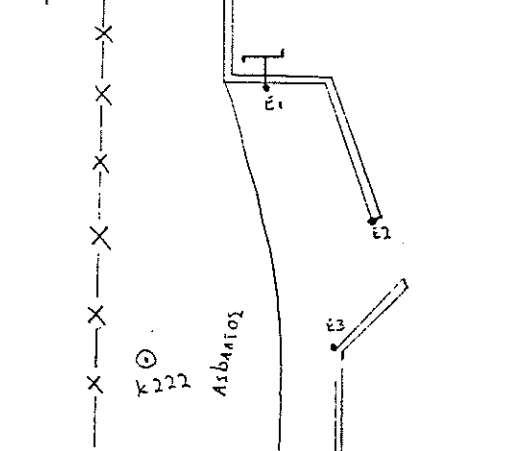
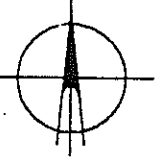
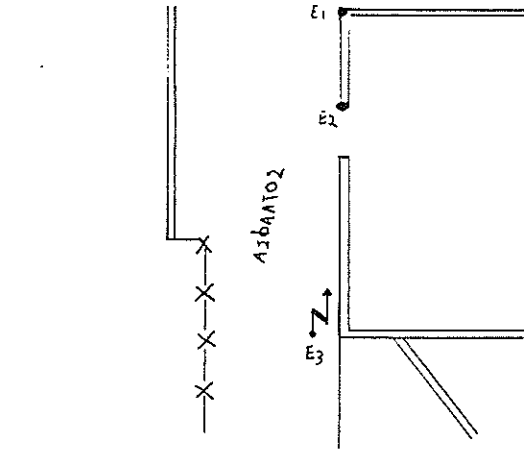
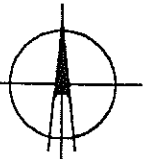
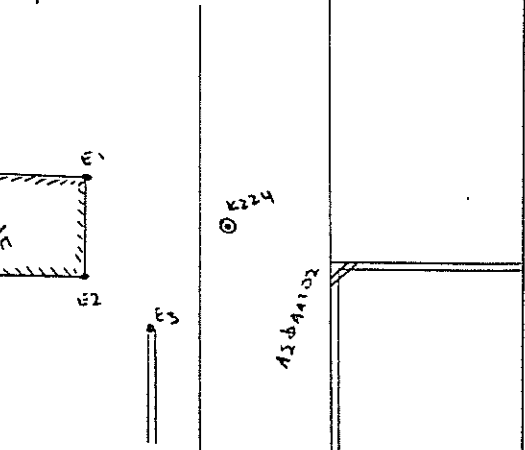
<div style="text-align: center;">  <p>ΚΑΡΦΙ K 221</p> </div>  <p style="text-align: center;"> $E_1 = 3.76$ (ΚΟΛΩΝΑ ΔΕΗ) $E_2 = 7.41$ (ΓΩΝΙΑ ΜΑΝΤΡΑΣ) $E_3 = 5.96$ (ΓΩΝΙΑ ΜΑΝΤΡΑΣ) </p>	<div style="text-align: center;">  <p>ΚΑΡΦΙ K 222</p> </div>  <p style="text-align: center;"> $E_1 = 24.42$ (ΚΟΛΩΝΑ ΟΓΕ) $E_2 = 14.85$ (ΓΩΝΙΑ ΜΑΝΤΡΑΣ) $E_3 = 4.55$ (ΓΩΝΙΑ ΜΑΝΤΡΑΣ) </p>
<div style="text-align: center;">  <p>ΚΑΡΦΙ K 223</p> </div>  <p style="text-align: center;"> $E_1 =$ $E_2 =$ $E_3 =$ </p>	<div style="text-align: center;">  <p>ΚΑΡΦΙ K 224</p> </div>  <p style="text-align: center;"> $E_1 = 2.70$ (ΓΩΝΙΑ ΟΙΚΙΑΣ) $E_2 = 3.66$ (ΓΩΝΙΑ ΟΙΚΙΑΣ) $E_3 = 5.89$ (ΓΩΝΙΑ ΜΑΝΤΡΑΣ) </p>

ΕΞΑΣΦΑΛΙΣΕΙΣ ΚΟΡΥΦΩΝ

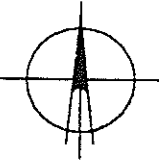
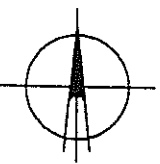
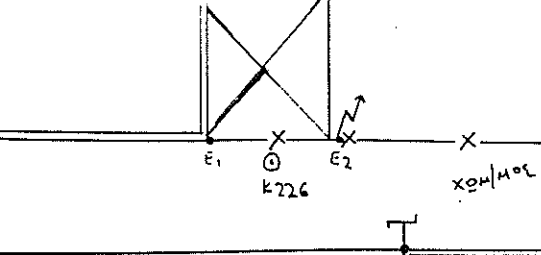
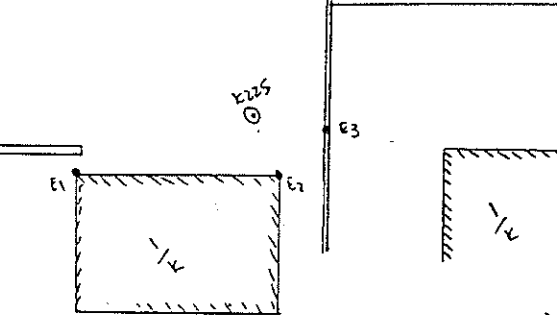
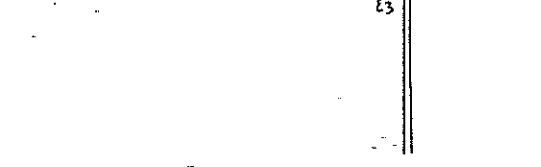
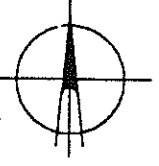
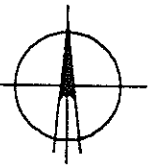
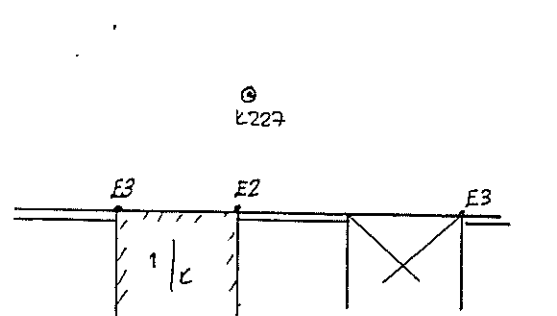
 <p>ΣΤΑΘΜΟ K 295</p>	 <p>ΣΤΑΘΜΟ K 296</p>
<p>ΧΩΗ/ΜΟΣ</p>	
	
<p>E1 = 5.20 (ΓΩΝΙΑ ΟΙΚΙΑΣ)..... E2 = 1.48 (ΓΩΝΙΑ ΟΙΚΙΑΣ)..... E3 = 1.53 ΣΜΑΝΤΡΑ.....</p>	<p>E1 = 4.92 (ΓΩΝΙΑ ΜΑΝΤΡΑΣ)..... E2 = 0.75 (ΚΟΛΩΝΑ ΔΕΗ)..... E3 = 4.82 (ΚΟΛΩΝΑ ΟΤΕ).....</p>
 <p>K 297</p>	 <p>K 298</p>
<p>⊙ K 227</p> 	<p>δεν εξασφαλίζεται</p>
<p>E1 = 11.62 (ΜΑΝΤΡΑ)..... E2 = 6.85 (.....)..... E3 = 11.86 (.....).....</p>	<p>E1 = E2 = E3 =</p>

ΕΞΑΣΦΑΛΙΣΕΙΣ ΚΟΡΥΦΩΝ

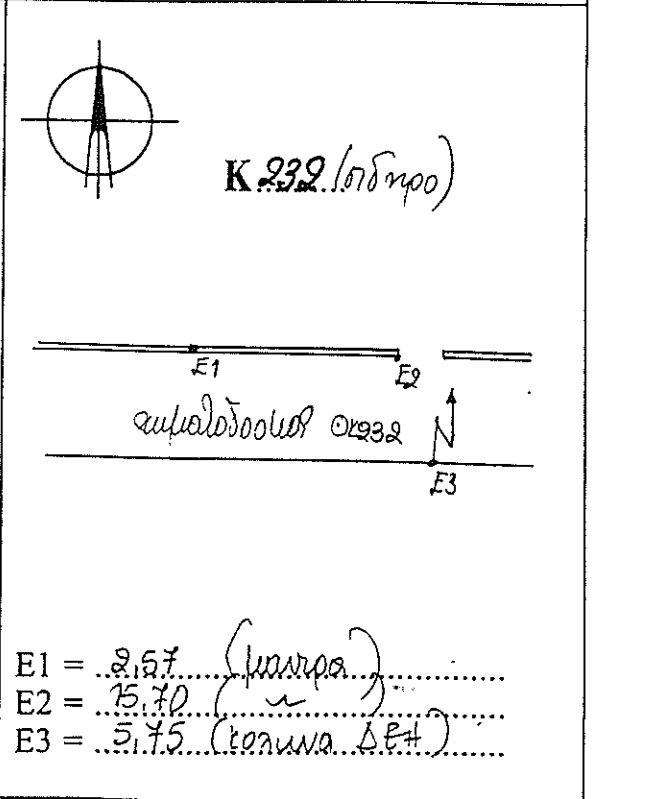
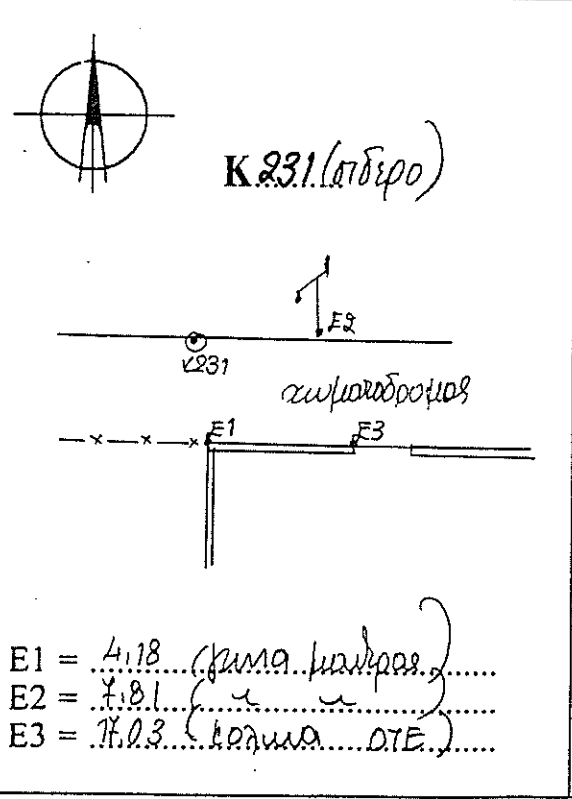
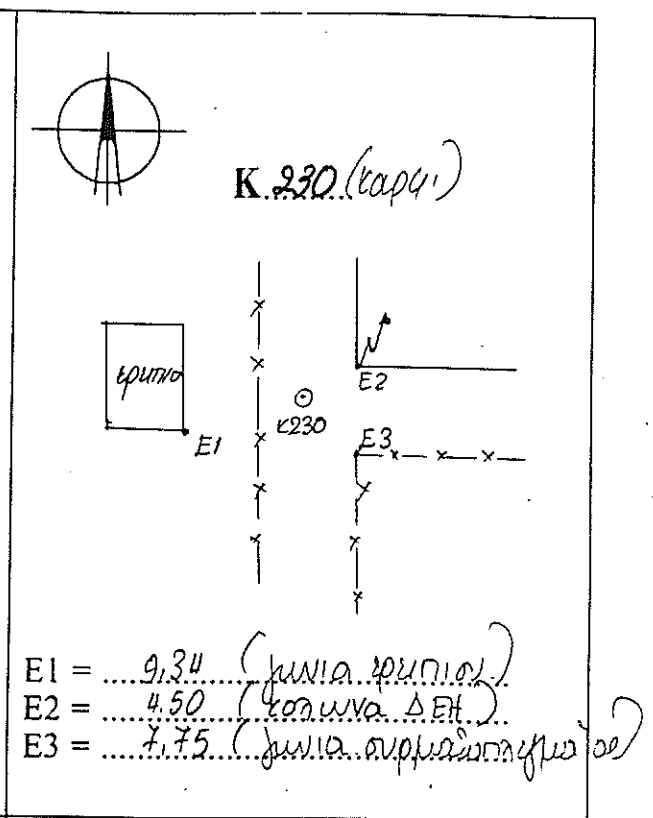
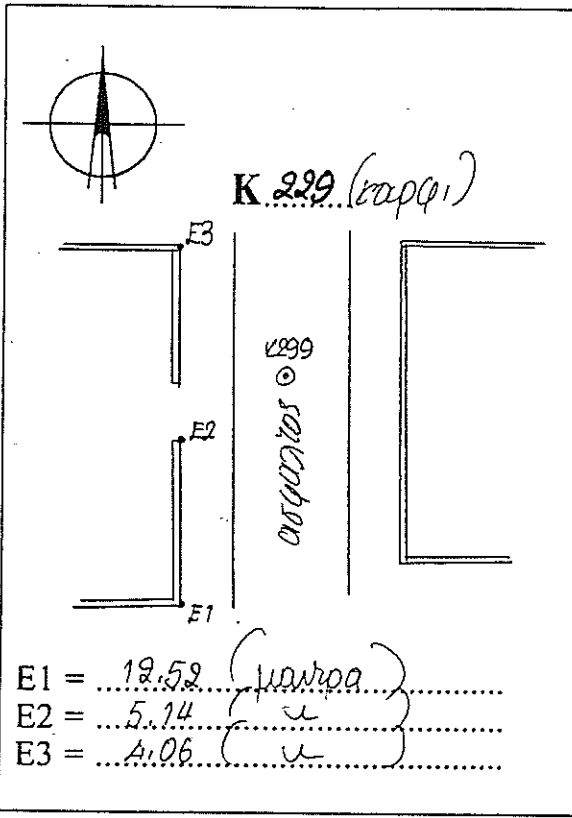

ΕΞΑΣΦΑΛΙΣΕΙΣ ΚΟΡΥΦΩΝ

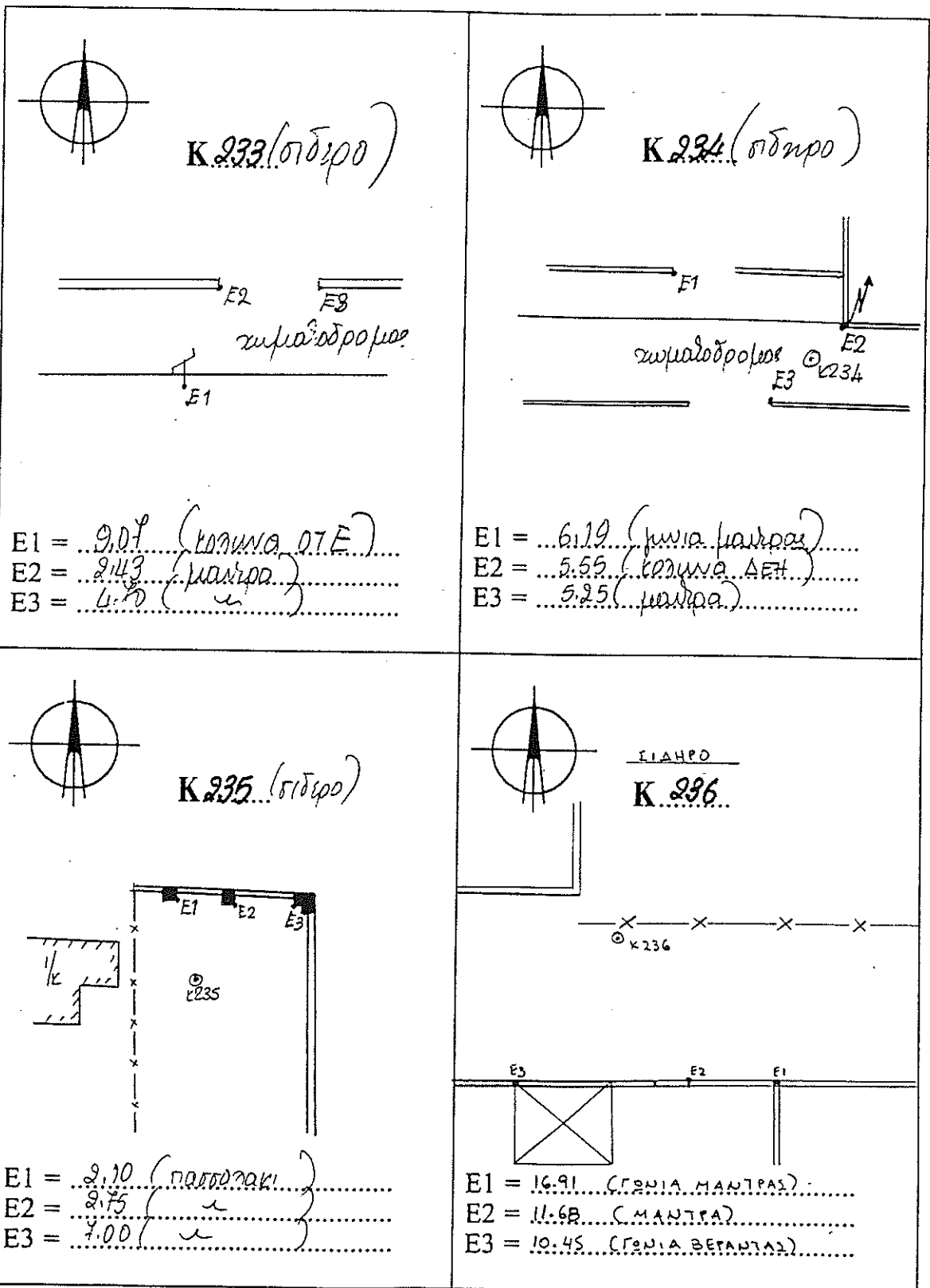

ΕΞΑΣΦΑΛΙΣΕΙΣ ΚΟΡΥΦΩΝ

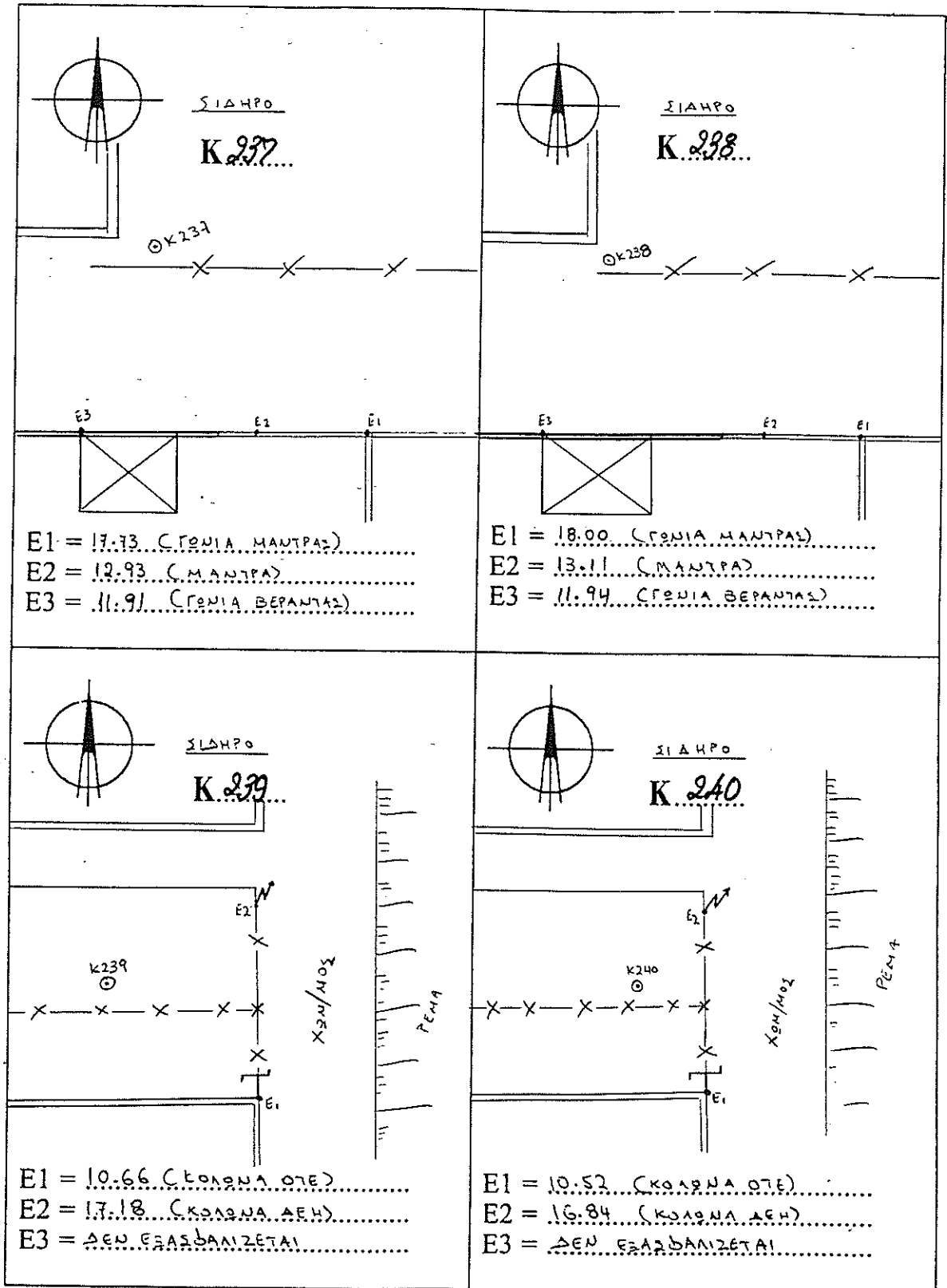

ΕΞΑΣΦΑΛΙΣΕΙΣ ΚΟΡΥΦΩΝ

ΣΙΔΗΡΟ
K.241

Ε1 = 12.74 (ΚΟΛΩΝΙΑ ΔΕΗ)
Ε2 = 2.26 (ΓΟΝΙΑ ΜΑΝΤΡΑΣ)
Ε3 = 14.64 (ΓΟΝΙΑ ΜΑΝΤΡΑΣ)

ΣΙΔΗΡΟ
K.242

ΔΕΝ ΕΞΑΣΦΑΛΙΖΕΤΑΙ

Ε1 =
Ε2 =
Ε3 =

ΣΙΔΗΡΟ
K.243

ΔΕΝ ΕΞΑΣΦΑΛΙΖΕΤΑΙ

Ε1 =
Ε2 =
Ε3 =

ΣΙΔΗΡΟ
K.244

ΔΕΝ ΕΞΑΣΦΑΛΙΖΕΤΑΙ

Ε1 =
Ε2 =
Ε3 =

ΕΞΑΣΦΑΛΙΣΕΙΣ ΚΟΡΥΦΩΝ

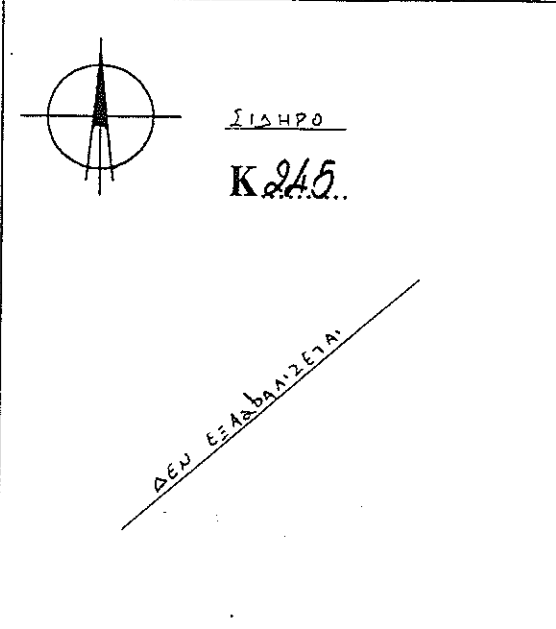
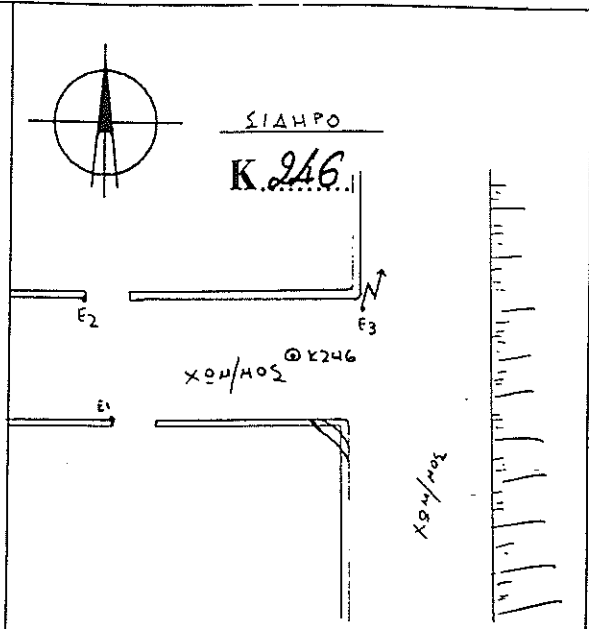
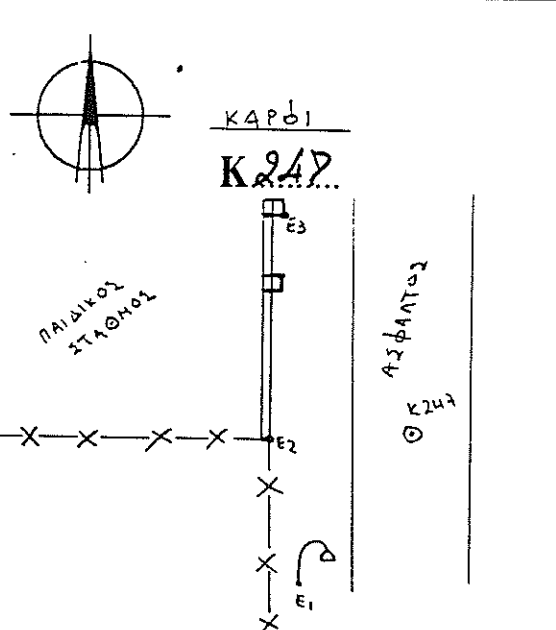
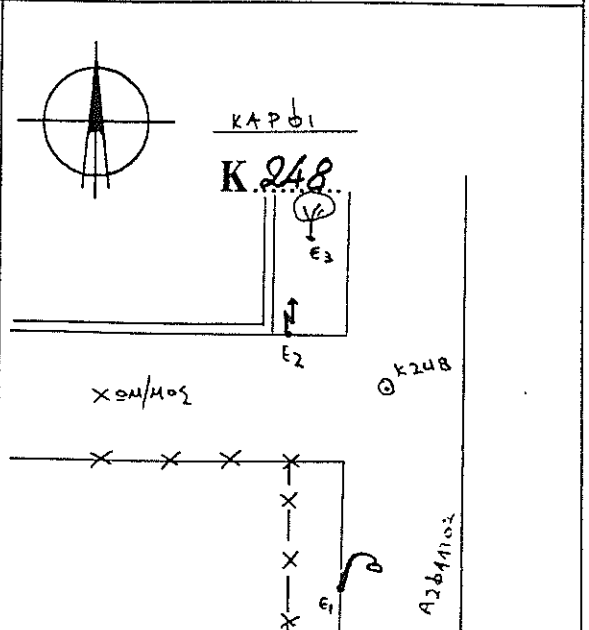
 <p>ΣΤΑΘΜΟ K245</p> <p>ΔΕΥ ΕΞΑΘΑΝΙΣΤΕΙΑ</p> <p>E1 = E2 = E3 =</p>	 <p>ΣΤΑΘΜΟ K246</p> <p>ΧΩΜ/ΜΟΣ</p> <p>ΧΩΜ/ΜΟΣ</p> <p>E1 = 10.05 (ΓΩΝΙΑ ΜΑΝΤΡΑΣ) E2 = 4.43 (ΓΩΝΙΑ ΜΑΝΤΡΑΣ) E3 = 4.65 (ΚΟΛΩΝΑ ΔΕΥ)</p>
 <p>ΚΑΡΦΙ K247</p> <p>ΠΑΛΙΝΟΣ ΣΤΑΘΜΟΣ</p> <p>ΑΣΦΑΛΤΟΣ</p> <p>E1 = 5.06 (ΦΩΤΙΣΤΙΚΟ) E2 = 6.09 (ΓΩΝΙΑ ΜΑΝΤΡΑΣ) E3 = 13.63 (ΚΟΛΩΝΑΕΙ)</p>	 <p>ΚΑΡΦΙ K248</p> <p>ΧΩΜ/ΜΟΣ</p> <p>ΑΣΦΑΛΤΟΣ</p> <p>E1 = 7.68 (ΦΩΤΙΣΤΙΚΟ) E2 = 7.99 (ΚΟΛΩΝΑ ΔΕΥ) E3 = 6.40 (ΕΥΚΑΛΥΠΤΟΣ)</p>

ΕΞΑΣΦΑΛΙΣΕΙΣ ΚΟΡΥΦΩΝ

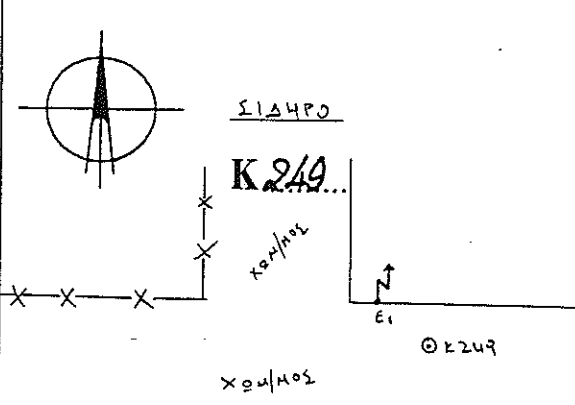
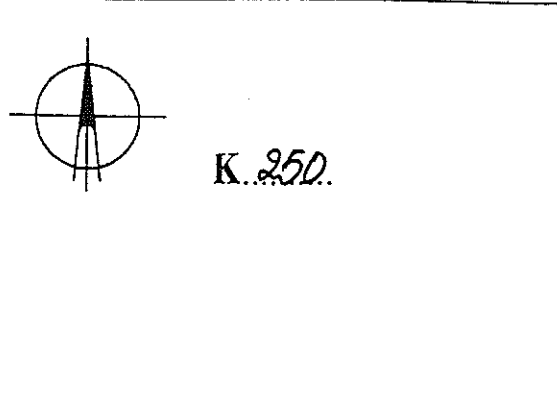
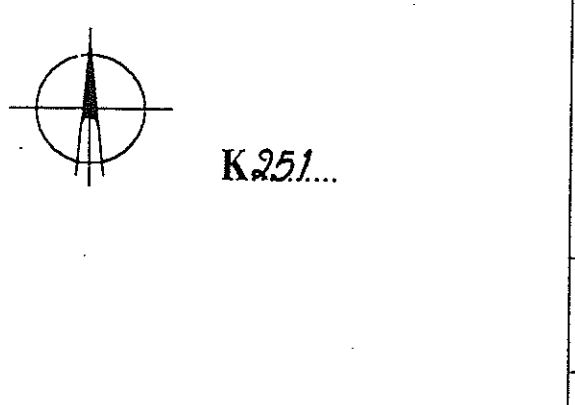
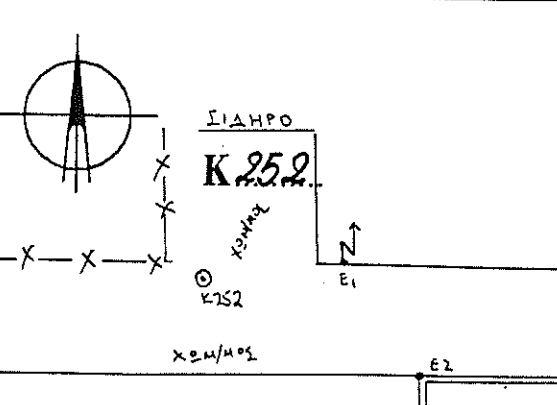
 <p style="text-align: center;">ΣΙΑΦΡΟ K.249</p> <p style="text-align: center;">⊙ K249</p> <p style="text-align: center;">E1</p> <p style="text-align: center;">E2</p> <p style="text-align: center;">E3</p> <p>E1 = 19.0 (ΣΚΟΛΩΝΑ ΔΕΗ)</p> <p>E2 = 18.41 (ΓΩΝΙΑ ΜΑΝΤΡΑΣ)</p> <p>E3 = 14.50 (ΓΩΝΙΑ ΜΑΝΤΡΑΣ)</p>	 <p style="text-align: center;">K.250</p> <p style="text-align: center;">E1 =</p> <p style="text-align: center;">E2 =</p> <p style="text-align: center;">E3 =</p>
 <p style="text-align: center;">K.251</p> <p style="text-align: center;">E1 =</p> <p style="text-align: center;">E2 =</p> <p style="text-align: center;">E3 =</p>	 <p style="text-align: center;">ΣΙΑΦΡΟ K.252</p> <p style="text-align: center;">⊙ K252</p> <p style="text-align: center;">E1</p> <p style="text-align: center;">E2</p> <p style="text-align: center;">E3</p> <p>E1 = 4.13 (ΣΚΟΛΩΝΑ ΔΕΗ)</p> <p>E2 = 14.09 (ΓΩΝΙΑ ΜΑΝΤΡΑΣ)</p> <p>E3 = 13.51 (ΓΩΝΙΑ ΜΑΝΤΡΑΣ)</p>

ΕΞΑΣΦΑΛΙΣΕΙΣ ΚΟΡΥΦΩΝ

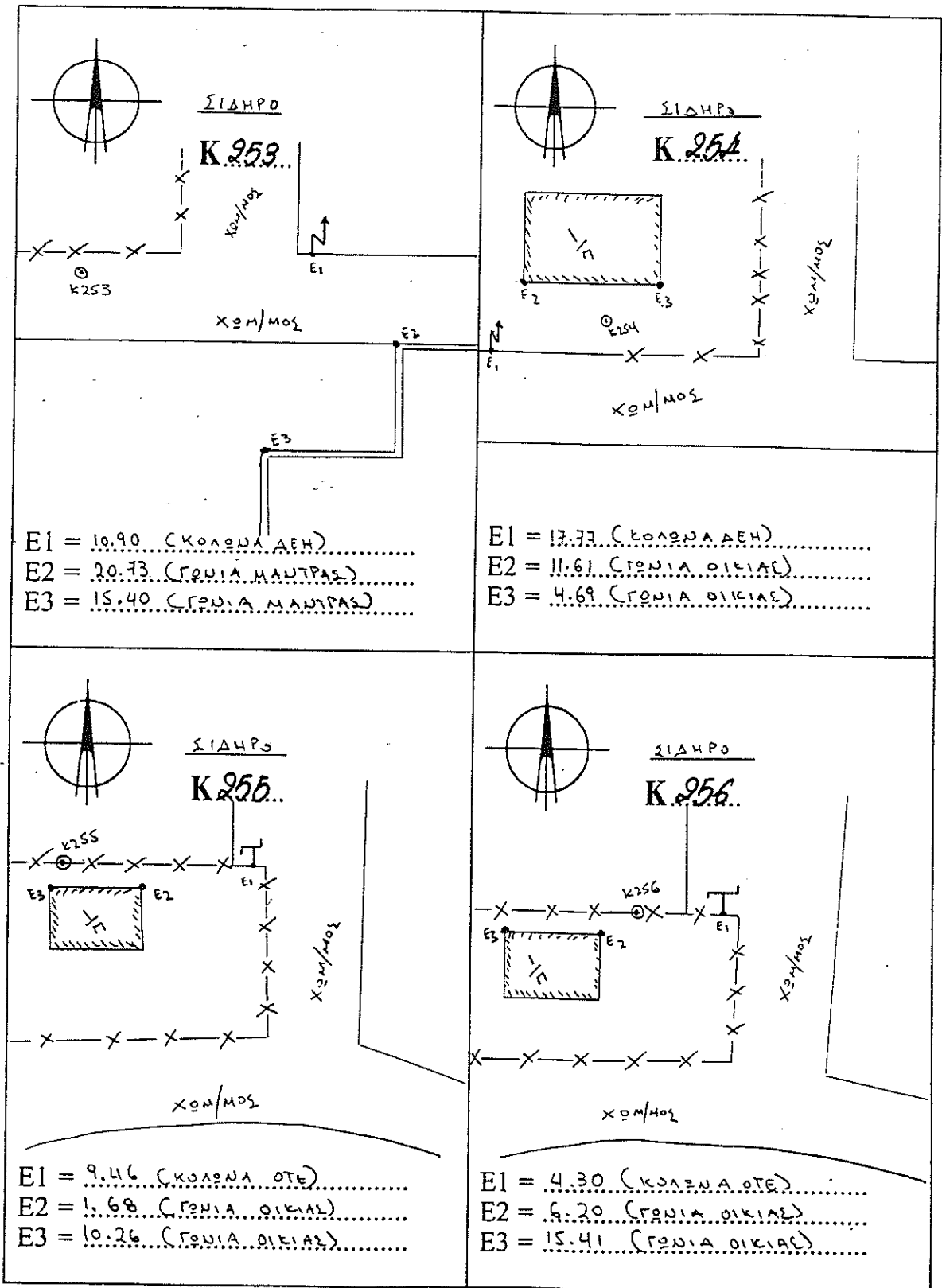

ΕΞΑΣΦΑΛΙΣΕΙΣ ΚΟΡΥΦΩΝ

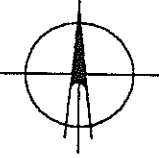
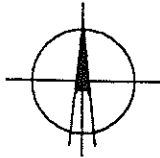
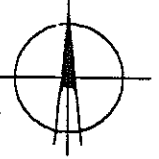
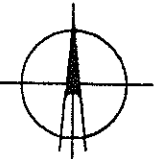
 <p>K.257...</p> <p>E1 = E2 = E3 =</p>	 <p>K.258...</p> <p>E1 = E2 = E3 =</p>
 <p>K.259..</p> <p>E1 = E2 = E3 =</p>	 <p>K.260...</p> <p><i>Την επομένη</i></p> <p>E1 = E2 = E3 =</p>

ΕΞΑΣΦΑΛΙΣΕΙΣ ΚΟΡΥΦΩΝ

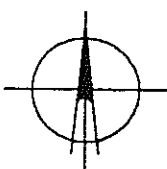
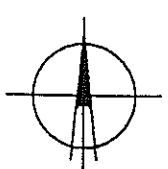
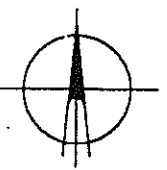
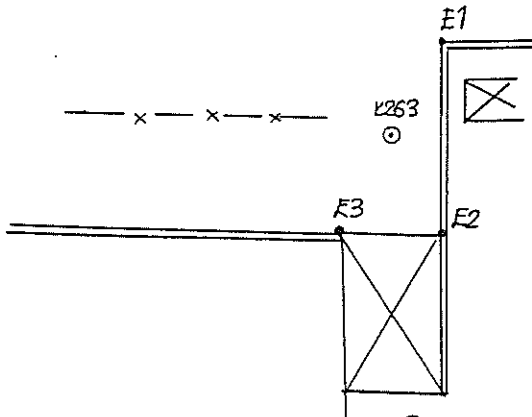
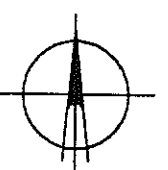
 <p>Κ261...</p> <p><i>δεν εξασφαλίσει</i></p> <p>E1 = E2 = E3 =</p>	 <p>Κ.262.</p> <p><i>δεν εξασφαλίσει</i></p> <p>E1 = E2 = E3 =</p>
 <p>Κ263 (σημείο)</p>  <p>E1 = 7.76 (φυλακία) } E2 = 3.76 () } E3 = 4.03 () }</p>	 <p>Κ.264.</p> <p><i>δεν εξασφαλίσει</i></p> <p>E1 = E2 = E3 =</p>

ΕΞΑΣΦΑΛΙΣΕΙΣ ΚΟΡΥΦΩΝ

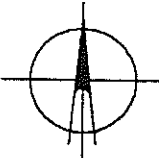
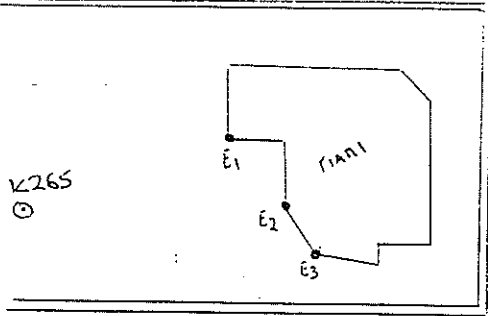
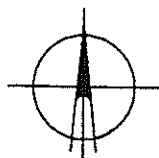
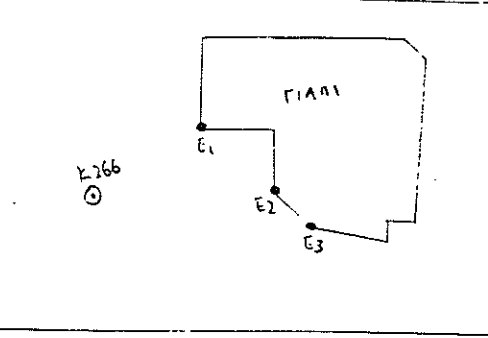
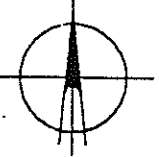
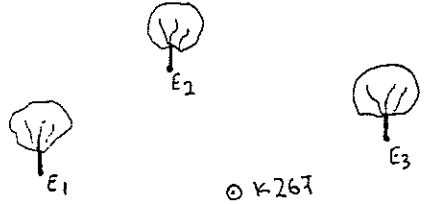
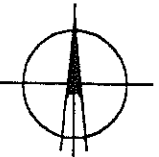
<div style="text-align: center;">  <p>ΣΙΔΗΡΟ Κ.265...</p> </div> <div style="text-align: center; border: 1px solid black; padding: 5px;">  <p>Κ.265</p> </div> <p>E1 = 8.48 (ΓΩΝΙΑ ΓΙΑΝΝΙΟΥ) E2 = 7.66 (ΓΩΝΙΑ ΓΙΑΝΝΙΟΥ) E3 = 8.93 (ΓΩΝΙΑ ΓΙΑΝΝΙΟΥ)</p>	<div style="text-align: center;">  <p>ΣΙΔΗΡΟ Κ.266...</p> </div> <div style="text-align: center; border: 1px solid black; padding: 5px;">  <p>Κ.266</p> </div> <p>E1 = 7.99 (ΓΩΝΙΑ ΓΙΑΝΝΙΟΥ) E2 = 7.00 (ΓΩΝΙΑ ΓΙΑΝΝΙΟΥ) E3 = 9.56 (ΓΩΝΙΑ ΓΙΑΝΝΙΟΥ)</p>
<div style="text-align: center;">  <p>ΣΙΔΗΡΟ Κ.267...</p> </div> <div style="text-align: center; border: 1px solid black; padding: 5px;">  <p>Κ.267</p> </div> <p>E1 = 3.67 (ΜΟΥΡΙΑ) E2 = 5.31 (ΚΕΡΑΣΙΑ) E3 = 4.71 (ΚΥΔΩΝΙΑ)</p>	<div style="text-align: center;">  <p>Κ...268</p> </div> <p>E1 = E2 = E3 =</p>

ΕΞΑΣΦΑΛΙΣΕΙΣ ΚΟΡΥΦΩΝ

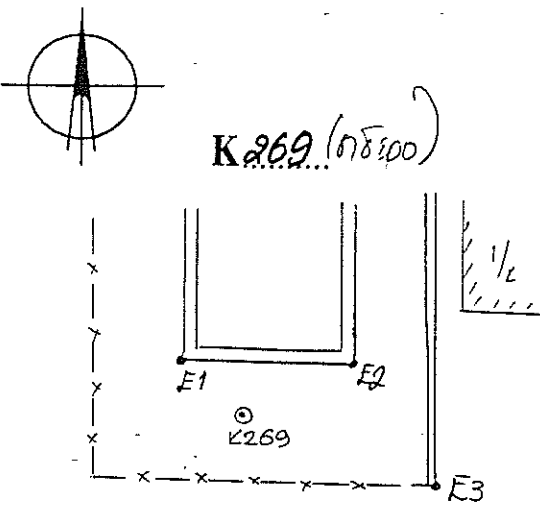
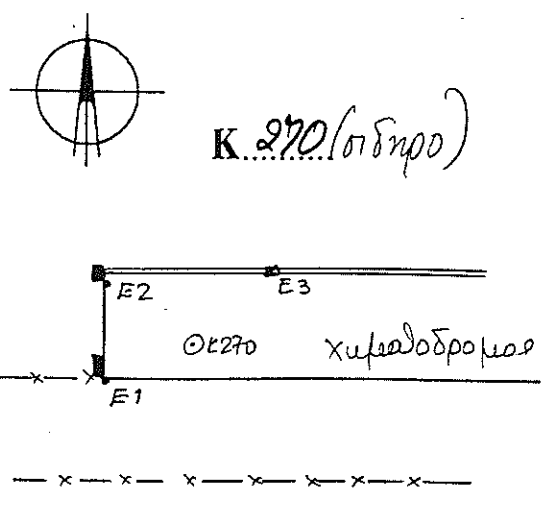
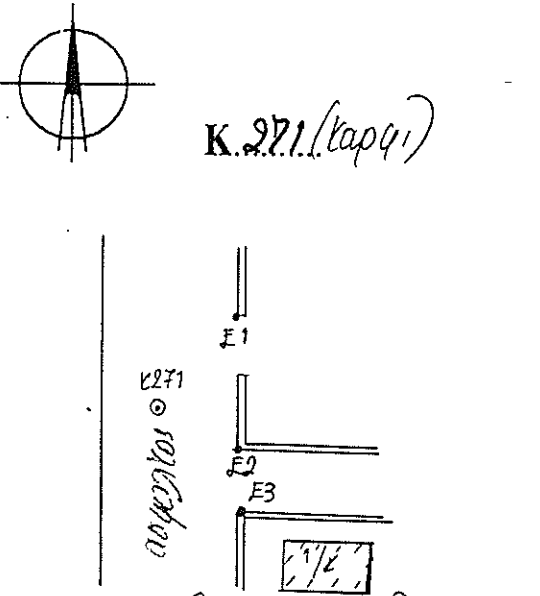
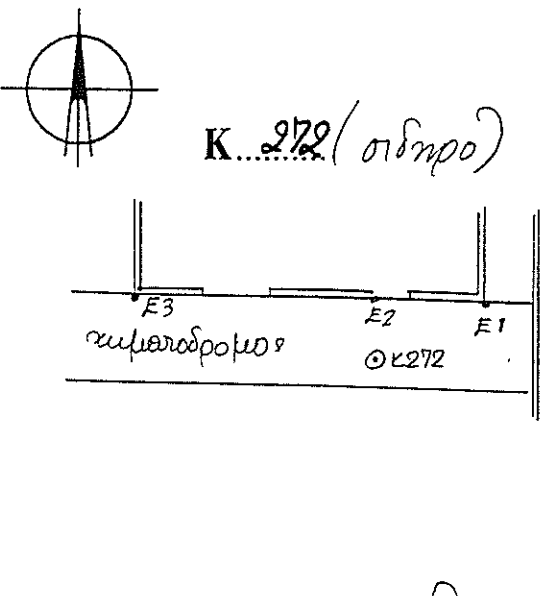
 <p>Κ 269 (πέτρα)</p> <p>E1 = 4.36 (γωνία μαύρας) E2 = 8.13 (u u) E3 = 12.49 (u u)</p>	 <p>Κ 270 (πέτρα)</p> <p>E1 = 4.20 (παύσαλα) E2 = 4.80 (u u) E3 = 5.13 (u u)</p>
 <p>Κ 271 (πέτρα)</p> <p>E1 = 9.91 (γωνία μαύρας) E2 = 5.20 (u u) E3 = 5.05 (u u)</p>	 <p>Κ 272 (πέτρα)</p> <p>E1 = 3.77 (γωνία μαύρας) E2 = 3.09 (u u) E3 = 9.88 (u u)</p>

ΕΞΑΣΦΑΛΙΣΕΙΣ ΚΟΡΥΦΩΝ

Κ.273 (στέφο)

σφαγγείο

E1 = 0.63 (στέφορα σταλός)

E2 = 10.07 (κολλω)

E3 = 3.72 (πενκο)

Κ.274 (καρφι)

σφαγγείο

E1 = 0.84 (στέφορα σταλός)

E2 = 9.71 (κολλω)

E3 = 2.04 (πενκο)

Κ.275 (καρφι)

σφαγγείο

αυτοκινητοδρόμο

E1 = 10.10 (δένδρο)

E2 = 3.78 (κολλω ΔΕΤ)

E3 = 5.50 (πενκο ΔΤΕ)

Κ.276...

δεν εφασταται

E1 =

E2 =

E3 =

ΕΞΑΣΦΑΛΙΣΕΙΣ ΚΟΡΥΦΩΝ

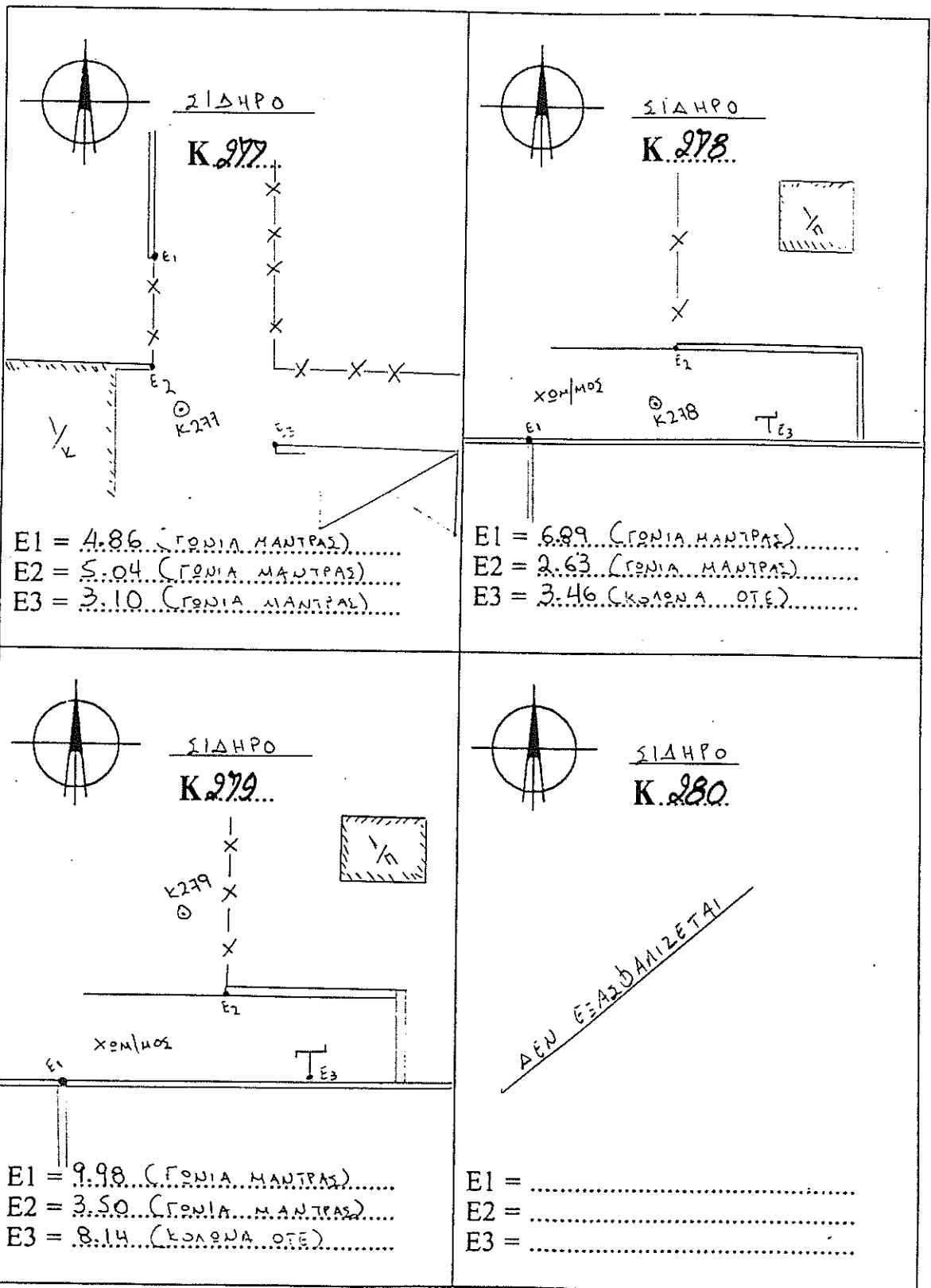

ΕΞΑΣΦΑΛΙΣΕΙΣ ΚΟΡΥΦΩΝ

Κ. 281 (σιδερο)

E1 E2 E3

Δεξαμενή

Κ281

E1 = 7.64 (μια μολοχα)
 E2 = 4.93 (μια μολοχα)
 E3 = 9.01 (μια δεξαμενή)

Κ. 282 (σιδερο)

E1 E2 E3

Δεξαμενή

Κ282

E1 = 6.97 (μια μολοχα)
 E2 = 3.94 (μια μολοχα)
 E3 = 9.89 (μια δεξαμενή)

Κ. 283 (σιδερο)

E1 E2 E3

Δεξαμενή

Κ283

E1 = 5.97 (μια μολοχα)
 E2 = 8.96 (μια δεξαμενή)
 E3 = 10.77 (μια δεξαμενή)

ΣΙΑ ΗΡΟ

Κ. 284

ΑΡΧΗ ΕΞΑΣΦΑΛΙΣΤΕΑΙ

E1 =
 E2 =
 E3 =

ΕΞΑΣΦΑΛΙΣΕΙΣ ΚΟΡΥΦΩΝ

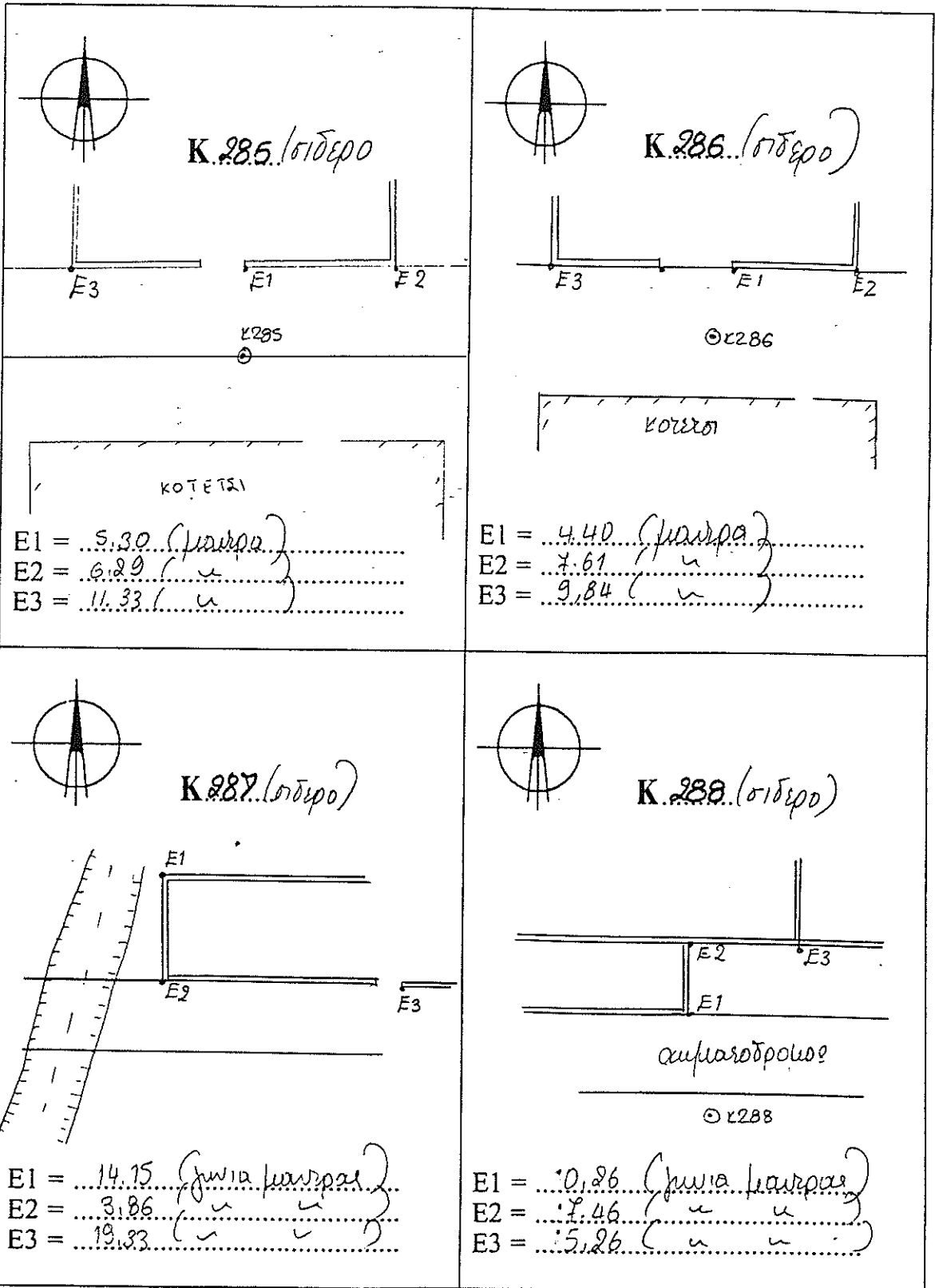

ΕΞΑΣΦΑΛΙΣΕΙΣ ΚΟΡΥΦΩΝ

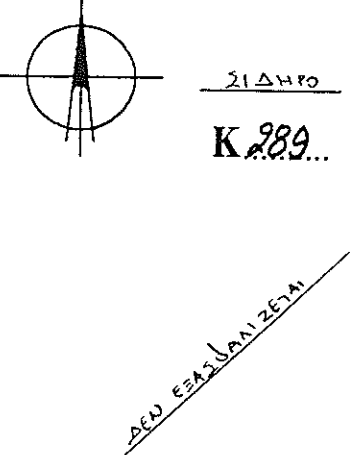
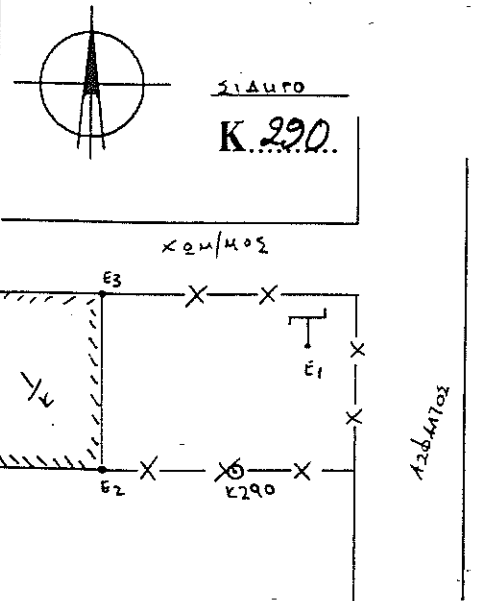
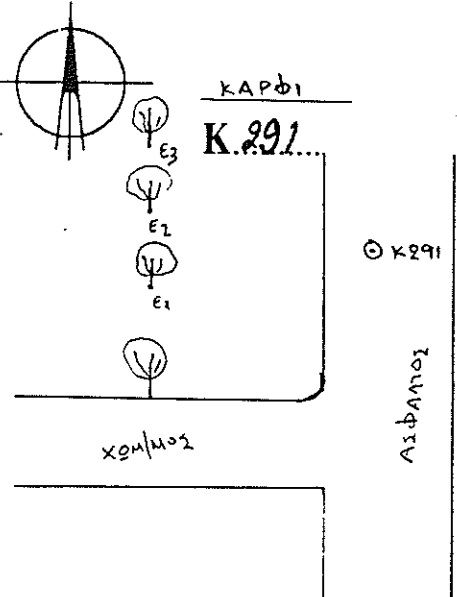
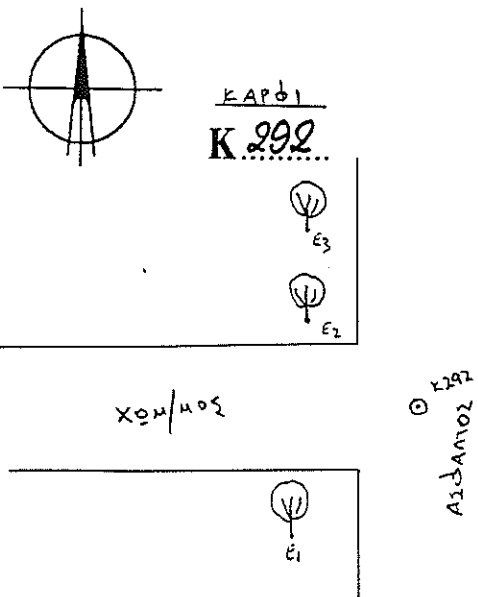
 <p>ΣΙΔΗΡΟ Κ.289</p> <p>ΔΕΝ ΕΞΑΣΦΑΛΙΖΕΤΑΙ</p> <p>E1 = E2 = E3 =</p>	 <p>ΣΙΔΗΡΟ Κ.290</p> <p>ΧΟΜ/ΜΟΣ</p> <p>E1 = 15.36 (ΚΟΛΩΝΑ ΔΕΗ) E2 = 9.92 (ΓΟΝΙΑ ΟΙΚΙΑΣ) E3 = 14.19 (ΓΟΝΙΑ ΟΙΚΙΑΣ)</p>
 <p>ΚΑΡΦΙ Κ.291</p> <p>ΧΟΜ/ΜΟΣ</p> <p>ΑΣΦΑΛΤΟΣ</p> <p>E1 = 8.67 (ΠΕΥΚΟ) E2 = 6.20 (ΠΕΥΚΟ) E3 = 9.20 (ΠΕΥΚΟ)</p>	 <p>ΚΑΡΦΙ Κ.292</p> <p>ΧΟΜ/ΜΟΣ</p> <p>ΑΣΦΑΛΤΟΣ</p> <p>E1 = 7.42 (ΠΕΥΚΟ) E2 = 8.16 (ΠΕΥΚΟ) E3 = 11.88 (ΠΕΥΚΟ)</p>

ΕΞΑΣΦΑΛΙΣΕΙΣ ΚΟΡΥΦΩΝ

<p>ΚΑΡΦΙ Κ. 293</p> <p>Ε3</p> <p>Ε2</p> <p>Ε1</p> <p>ΧΩΜ/ΜΟΣ</p> <p>Ε293 ΛΙΦΑΝΤΟΣ</p> <p>E1 = 8.53 (ΓΟΝΙΑ ΒΕΡΑΝΤΑΣ) E2 = 8.46 (ΕΔΩΝΑ ΔΕΗ) E3 = 10.75 (ΠΕΡΟΣ)</p>	<p>Κ. 294 (καρφι)</p> <p>Ε1</p> <p>Ε3</p> <p>Ε2</p> <p>Κ294</p> <p>1/η</p> <p>E1 = 8.16 (κοίμη ΔΕΗ) E2 = 6.47 (για μαύρα) E3 = 5.40</p>
<p>Κ. 295 (καρφι)</p> <p>Ε1</p> <p>Ε3</p> <p>Ε2</p> <p>Κ295</p> <p>1/η</p> <p>E1 = 10.44 (για συμπλοκισμούς) E2 = 15.22 (καίμα) E3 = 5.45 (κοίμη ΔΤΕ)</p>	<p>Κ. 296 (καρφι)</p> <p>Ε1</p> <p>Ε3</p> <p>Ε2</p> <p>Κ296</p> <p>1/η</p> <p>E1 = 14.21 (για συμπλοκισμούς) E2 = 19.79 (καίμα) E3 = 5.47 (κοίμη ΔΤΕ)</p>

ΕΞΑΣΦΑΛΙΣΕΙΣ ΚΟΡΥΦΩΝ

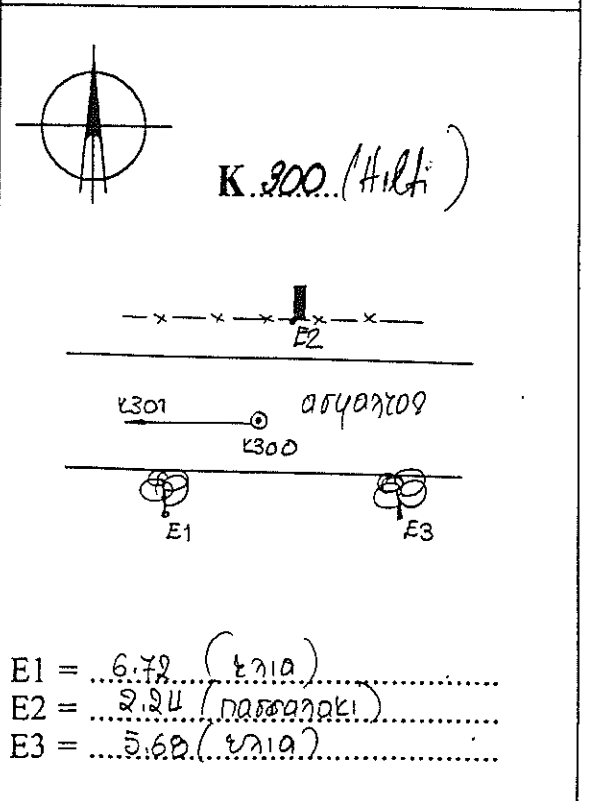
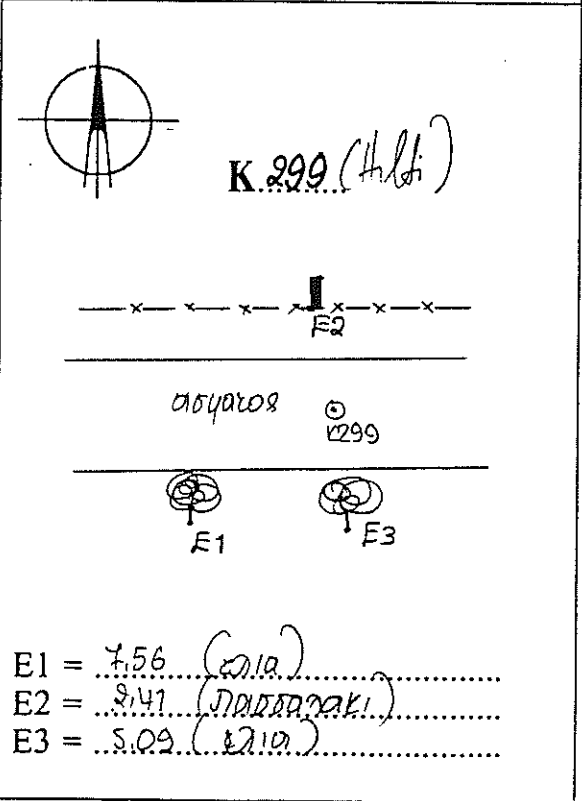
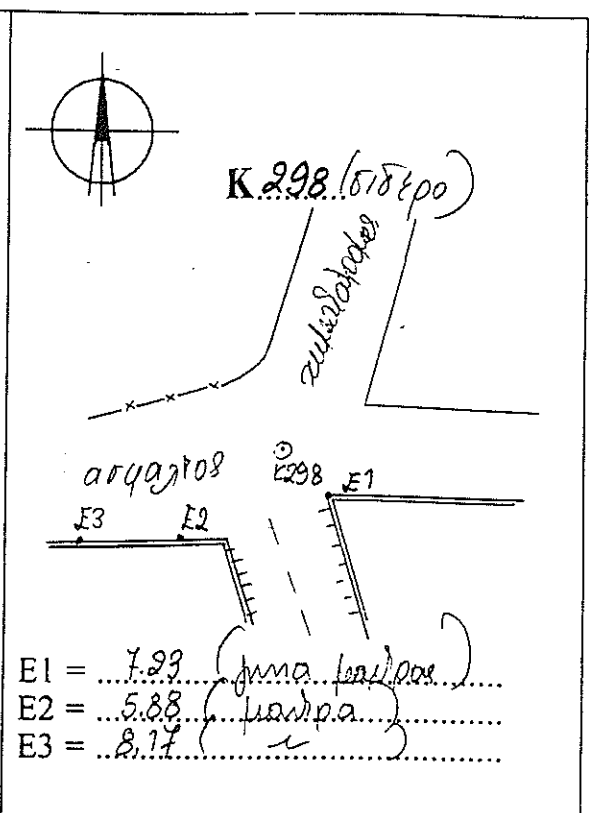
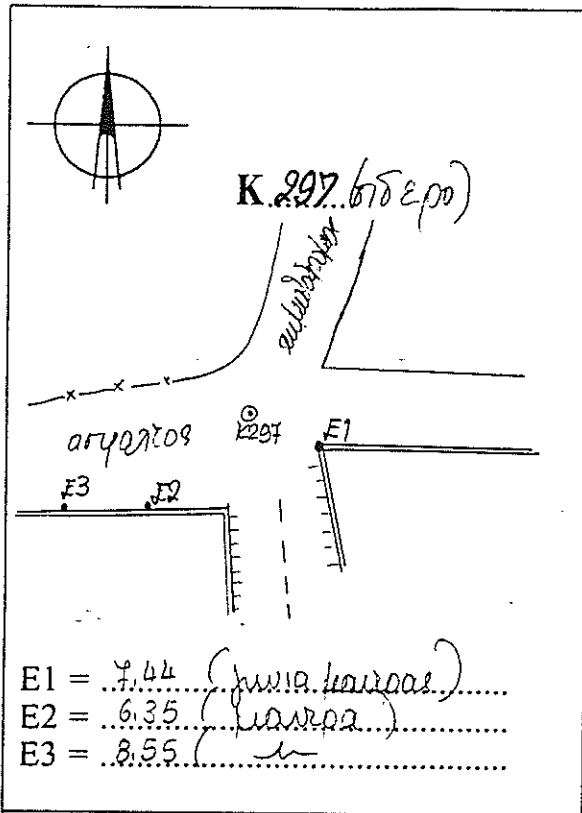

ΕΞΑΣΦΑΛΙΣΕΙΣ ΚΟΡΥΦΩΝ

K.301 (καρφί)

E1 = 2.46 (για μάλτρα)

E2 = 5.16 (κόστος ΔΕΗ)

E3 = 17.36

K.302 (καρφί)

E1 = 4.77 (κόστος ΔΕΗ)

E2 = 9.14 (μάλτρα)

E3 = 8.52

K.303 (σιδερό)

E1 = 10.65 (κόστος ΔΕΗ)

E2 = 13.03 (για ιδ. επιχώσ.)

E3 = 3.79 (μάλτρα)

K.304 (σιδερό)

E1 = 5.15 (σχηματοποίηση)

E2 = 9.93 (για σφ. κατασκευασμ. σφ.)

E3 = 5.46 (σχηματοποίηση)

ΕΞΑΣΦΑΛΙΣΕΙΣ ΚΟΡΥΦΩΝ

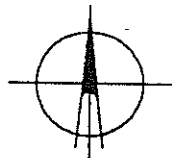

K.309...

E1 =
 E2 =
 E3 =

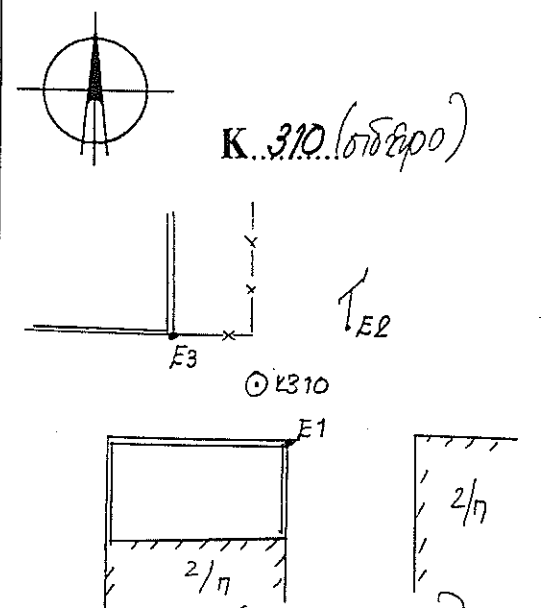

K.310 (σίδερο)

E1 = 3.75 (για κωνία)
 E2 = 5.58 (κοίμη ΟΤΕ)
 E3 = 2.41

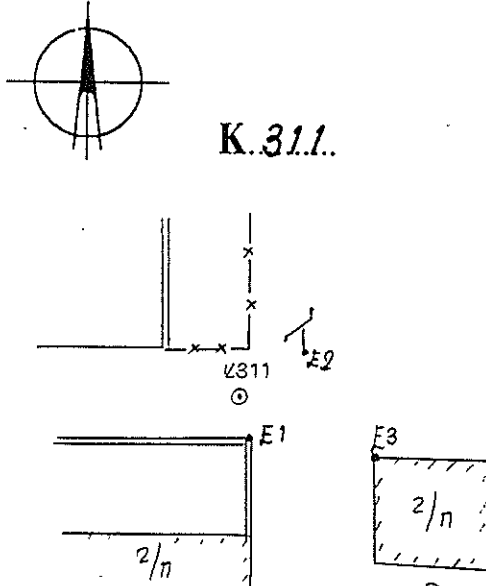

K.311.

E1 = 1.81 (για κωνία)
 E2 = 2.58 (κοίμη ΟΤΕ)
 E3 = 10.64 (για σπινάλι)

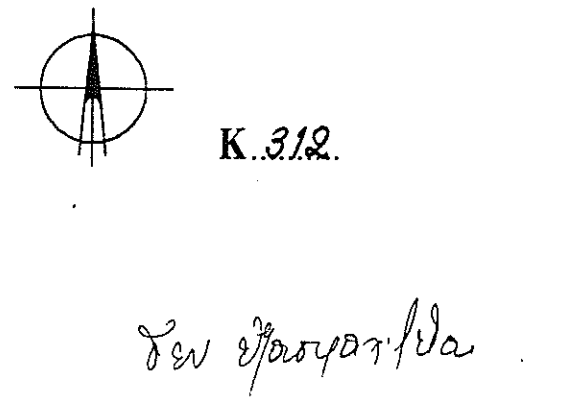

K.312.

δεν χρησιμοποιείται

E1 =
 E2 =
 E3 =

ΕΞΑΣΦΑΛΙΣΕΙΣ ΚΟΡΥΦΩΝ

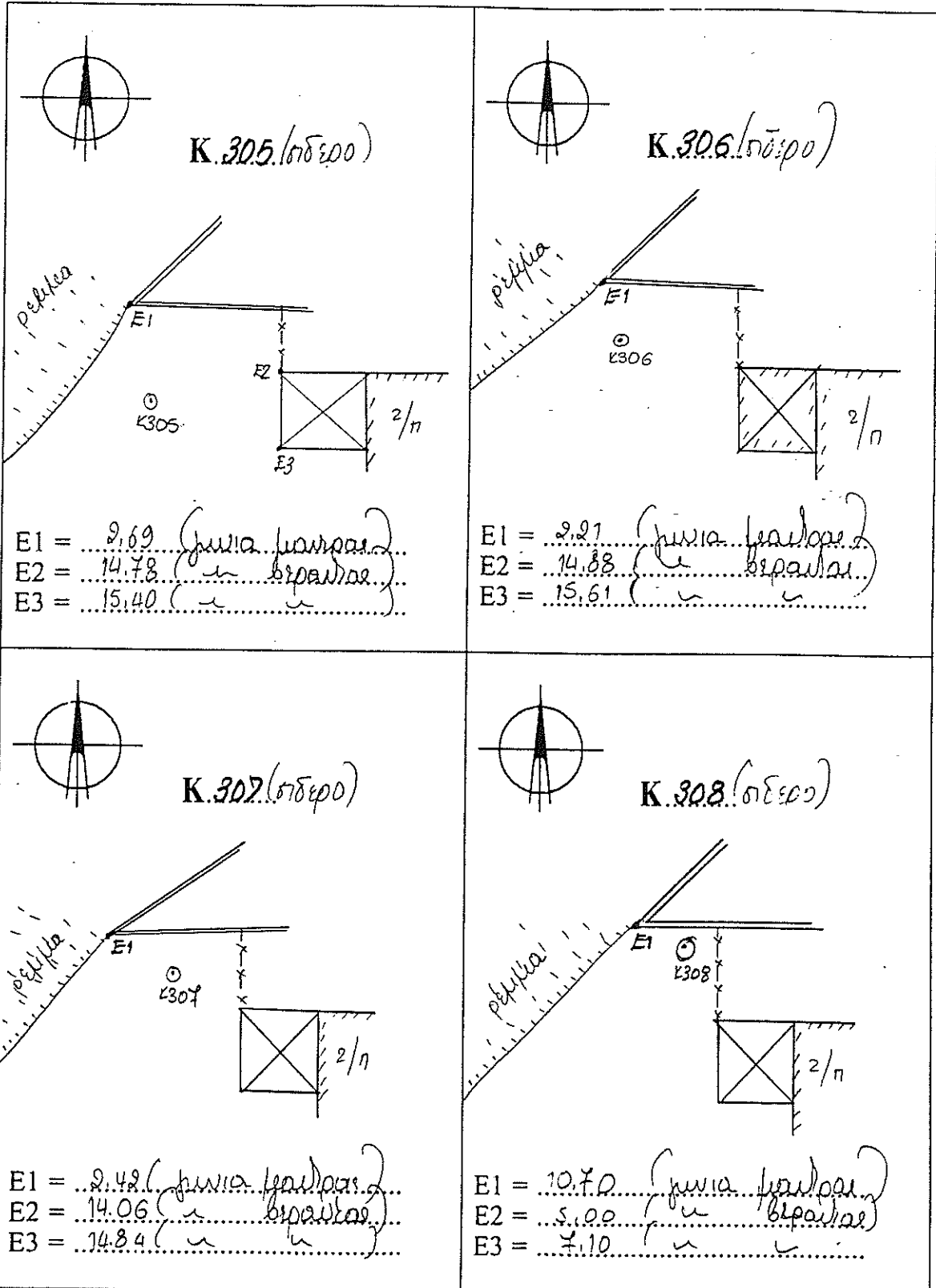

ΕΞΑΣΦΑΛΙΣΕΙΣ ΚΟΡΥΦΩΝ

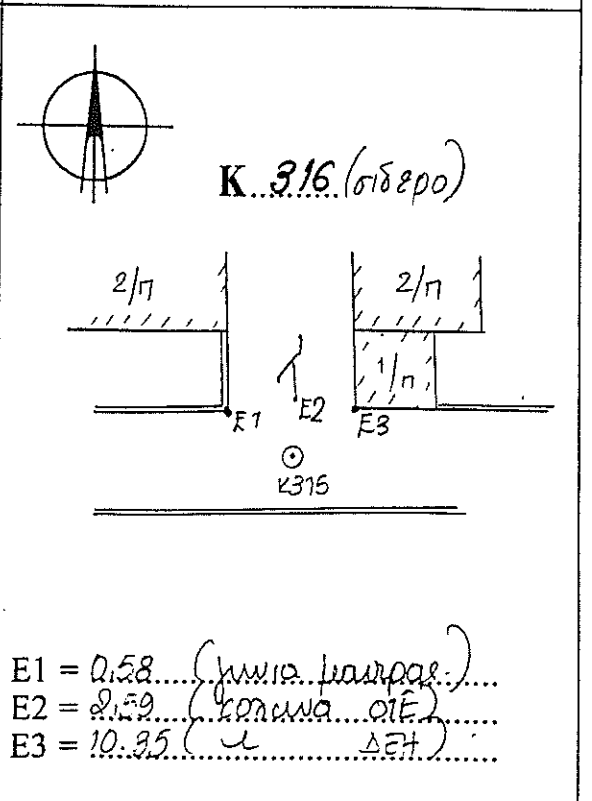
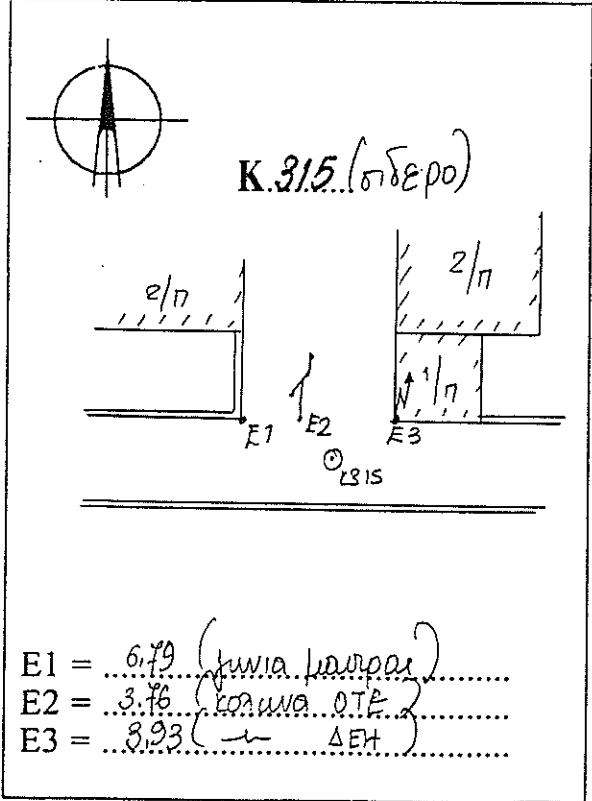
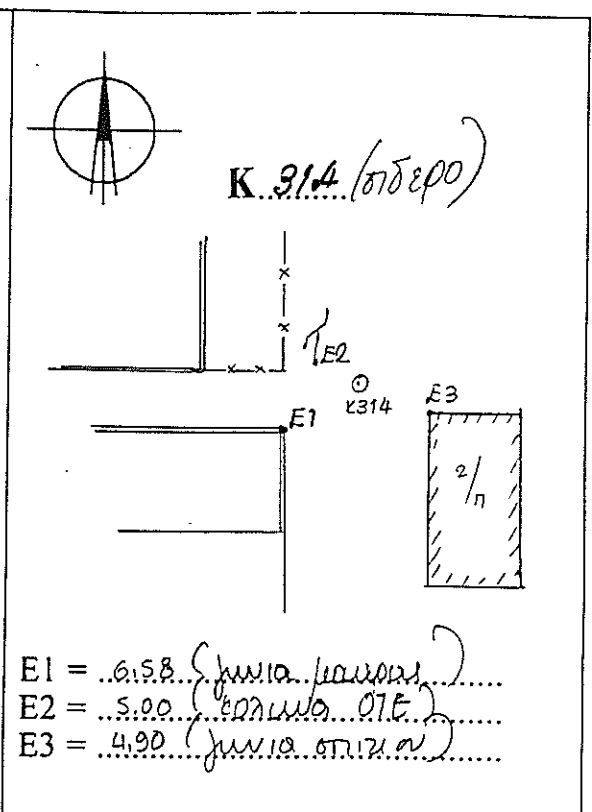
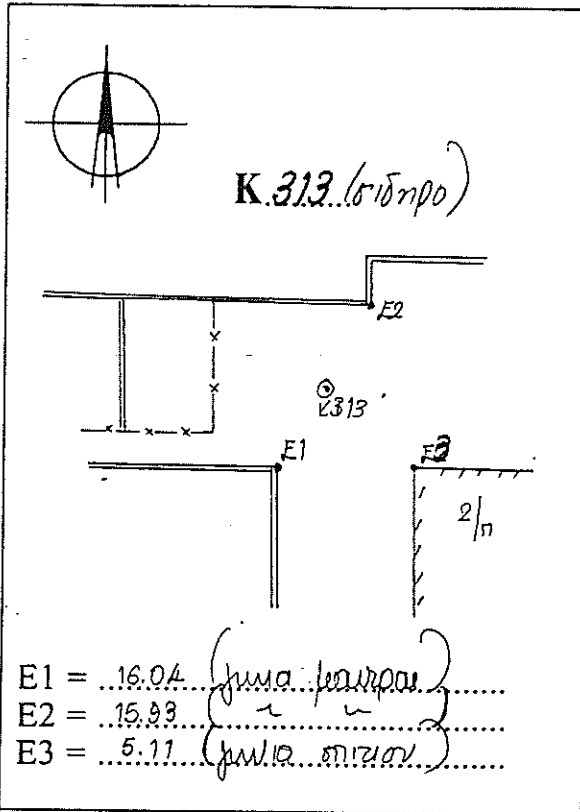

ΕΞΑΣΦΑΛΙΣΕΙΣ ΚΟΡΥΦΩΝ

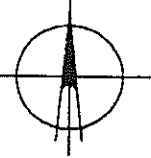
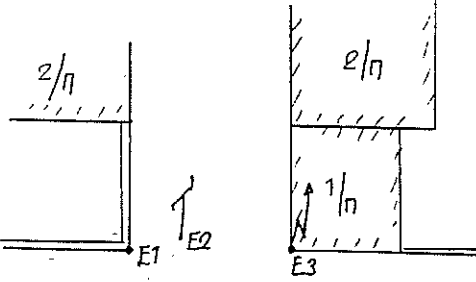
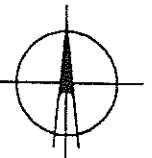
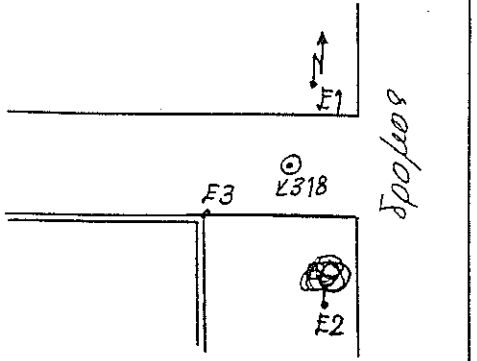
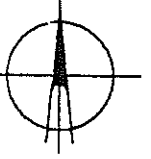
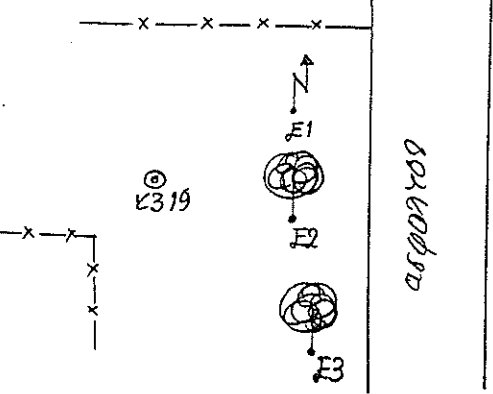
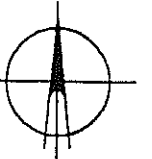
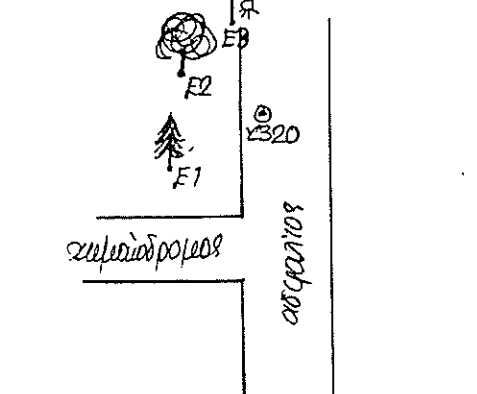
<div style="text-align: center;">  <p>Κ.317 (στδερρο)</p> </div> <div style="text-align: center;">  </div> <div style="margin-top: 20px;"> <p>E1 = 7.30 (γωνία κωδωσε) E2 = 4.89 (γωνία οτε) E3 = 4.80 (γωνία οπιτα)</p> </div>	<div style="text-align: center;">  <p>Κ.318 (στδερρο)</p> </div> <div style="text-align: center;">  </div> <div style="margin-top: 20px;"> <p>E1 = 12.53 (γωνία ΔΕΗ) E2 = 15.52 (γωνία οτε) E3 = 13.56 (γωνία κωδωσε)</p> </div>
<div style="text-align: center;">  <p>Κ.319 (στδερρο)</p> </div> <div style="text-align: center;">  </div> <div style="margin-top: 20px;"> <p>E1 = 14.15 (γωνία ΔΕΗ) E2 = 12.50 (γωνία οτε) E3 = 16.83 (γωνία κωδωσε)</p> </div>	<div style="text-align: center;">  <p>Κ.320 (κορφο)</p> </div> <div style="text-align: center;">  </div> <div style="margin-top: 20px;"> <p>E1 = 12.69 (γωνία οτε) E2 = 7.20 (γωνία κωδωσε) E3 = 8.55 (γωνία οπιτα)</p> </div>

ΕΞΑΣΦΑΛΙΣΕΙΣ ΚΟΡΥΦΩΝ

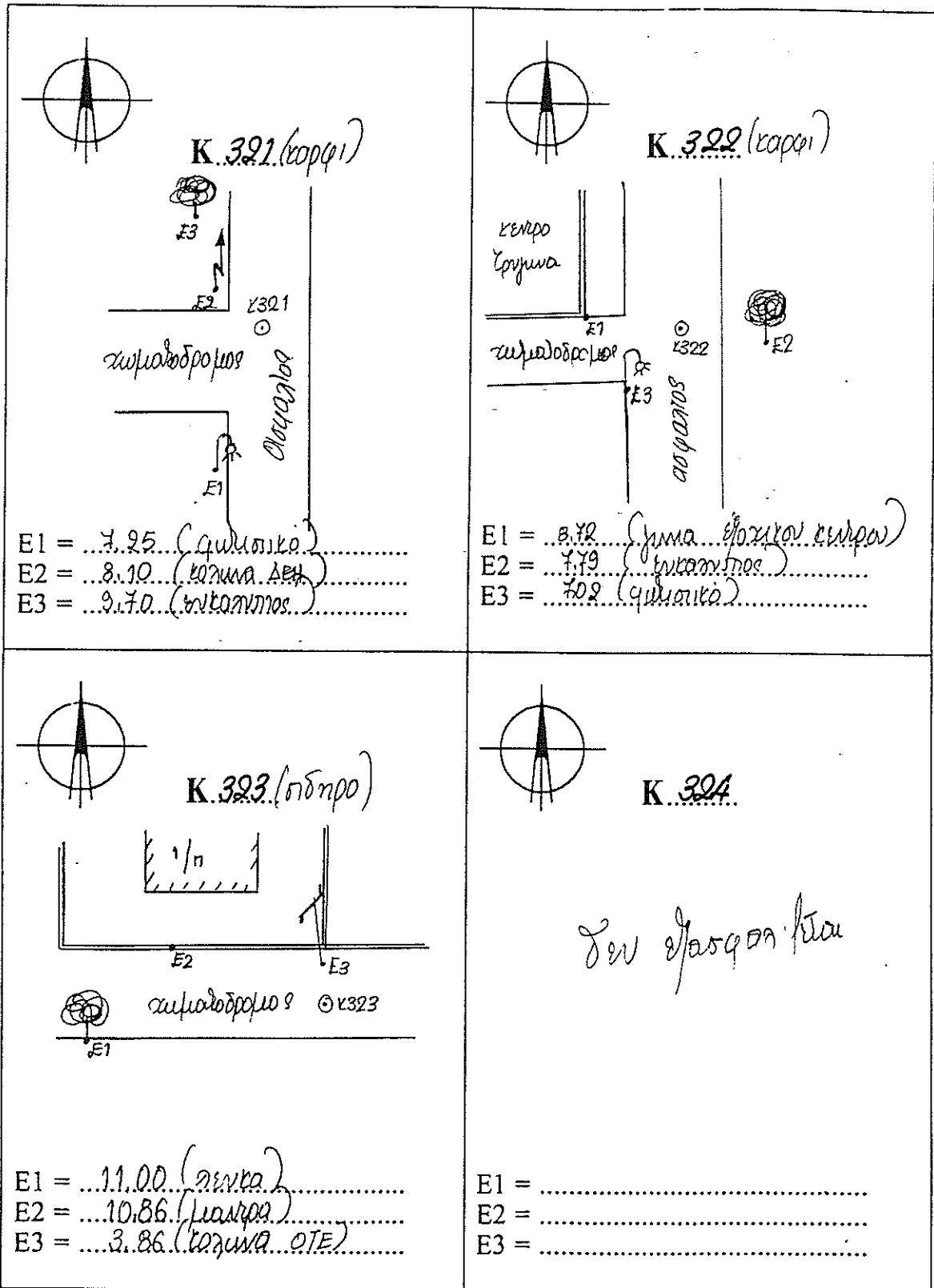

ΕΞΑΣΦΑΛΙΣΕΙΣ ΚΟΡΥΦΩΝ

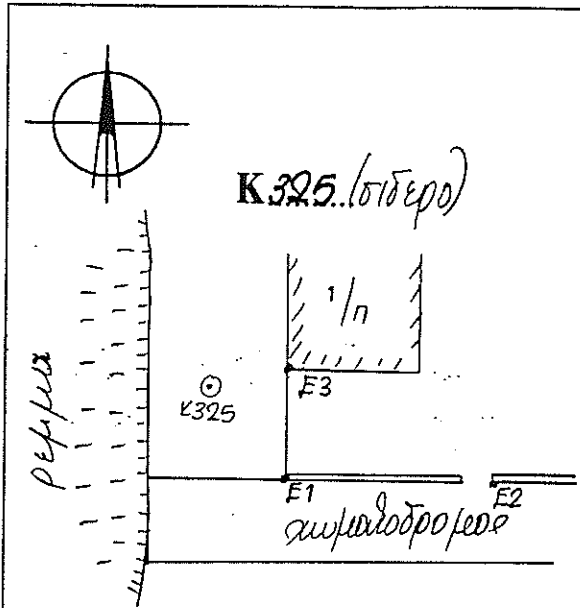

K325 (σιδερο)

E1 = 40.2 (μνία μαύρα)
 E2 = 9.46 (μνία α)
 E3 = 9.18 (μνία σπιζιαν)

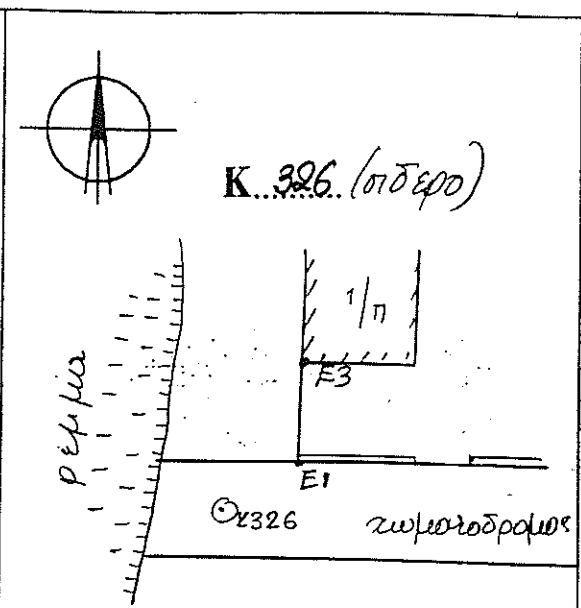

K326 (σιδερο)

E1 = 3.90 (μνία μαύρα)
 E2 =
 E3 = 9.10 (μνία σπιζιαν)

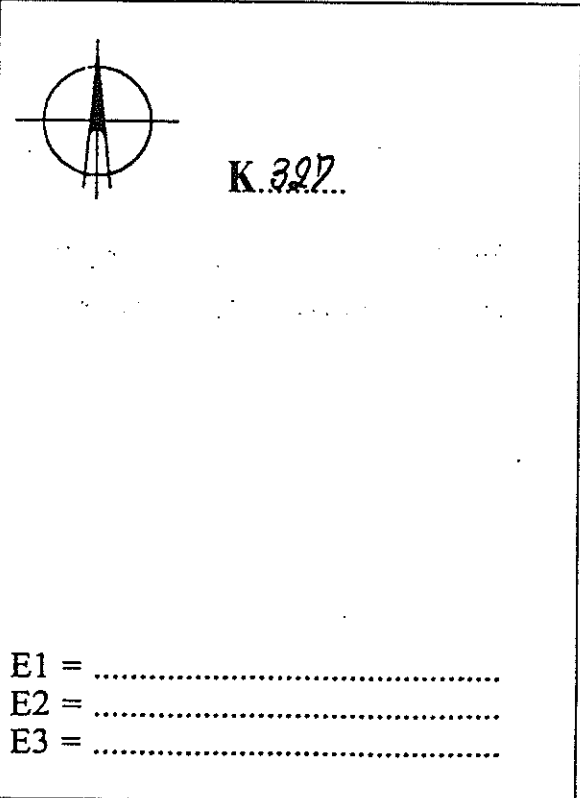

K327

E1 =
 E2 =
 E3 =

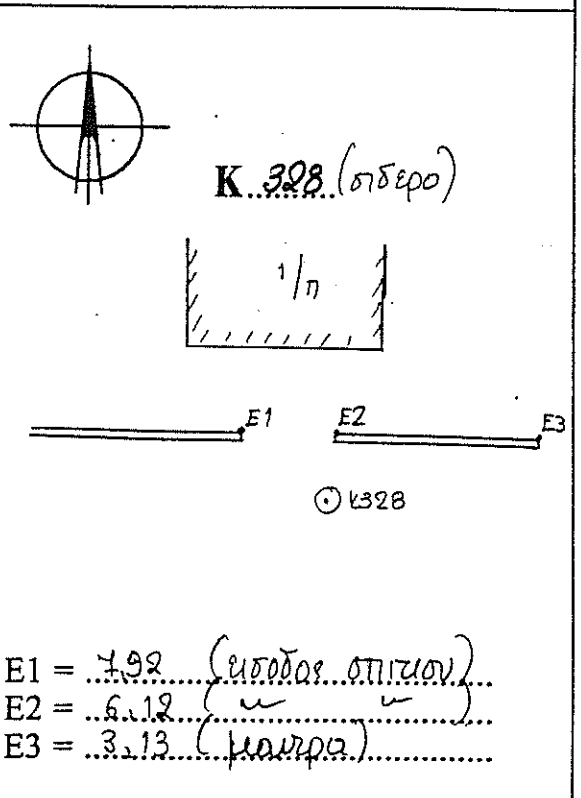

K328 (σιδερο)

E1 = 7.92 (εισοδα σπιζιαν)
 E2 = 6.12 (μνία α)
 E3 = 3.13 (μαύρα)

ΕΞΑΣΦΑΛΙΣΕΙΣ ΚΟΡΥΦΩΝ

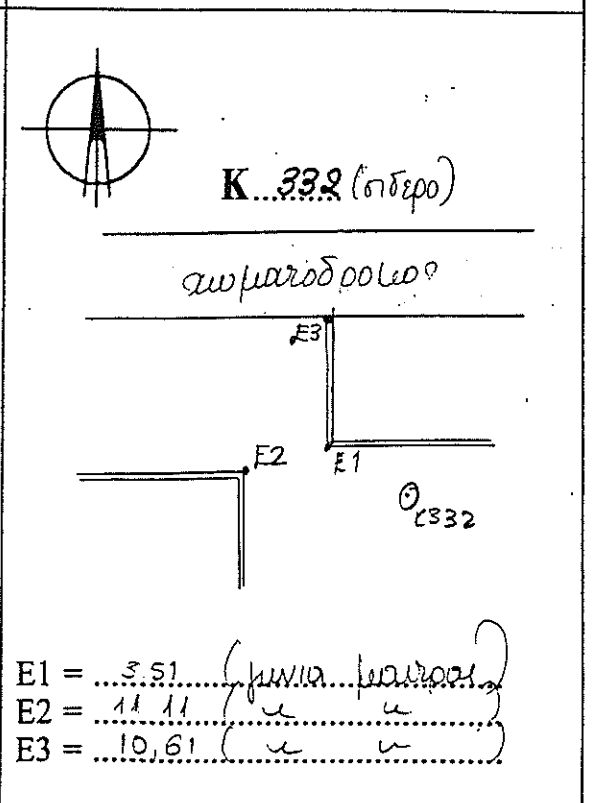
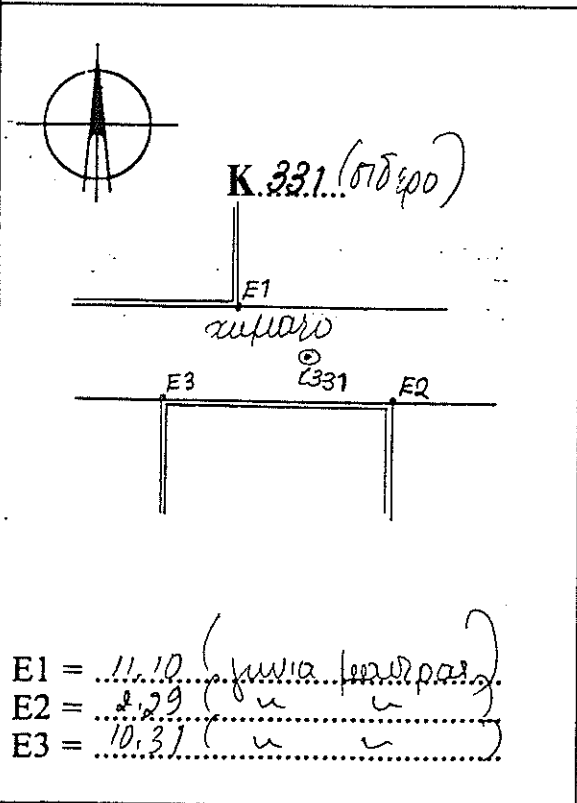
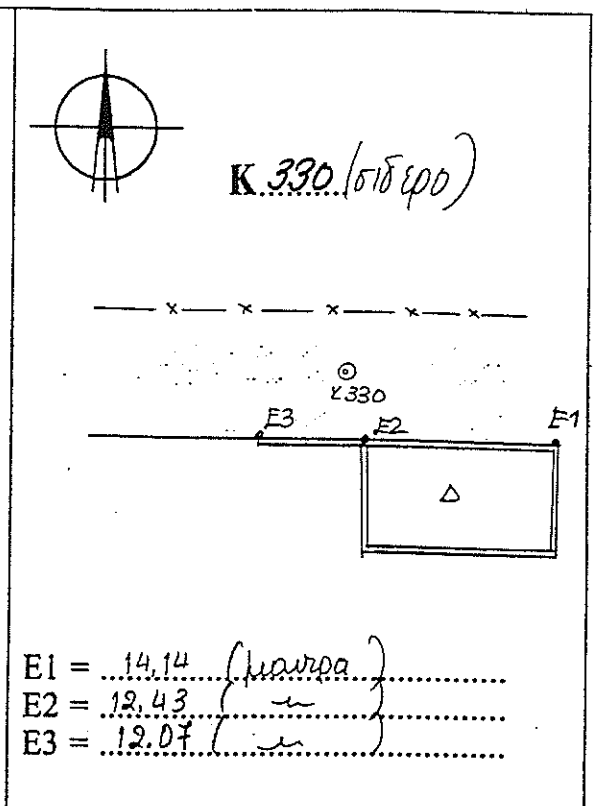
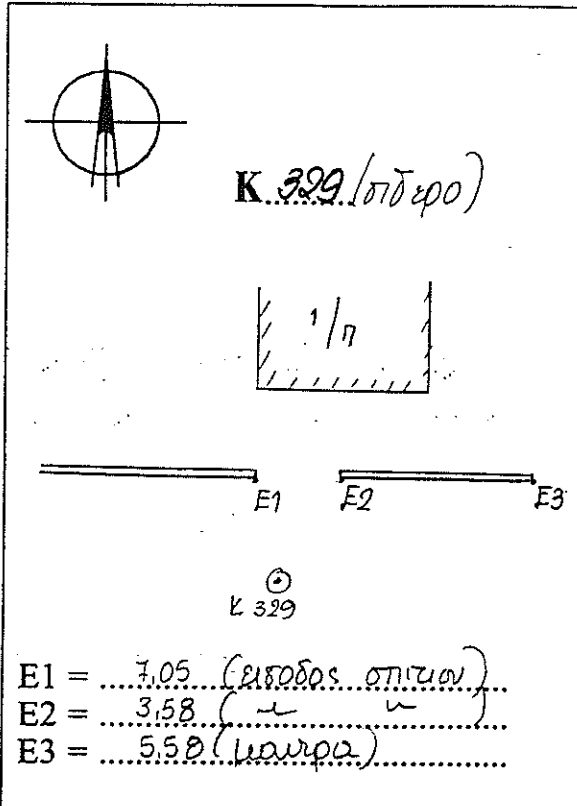

ΕΞΑΣΦΑΛΙΣΕΙΣ ΚΟΡΥΦΩΝ

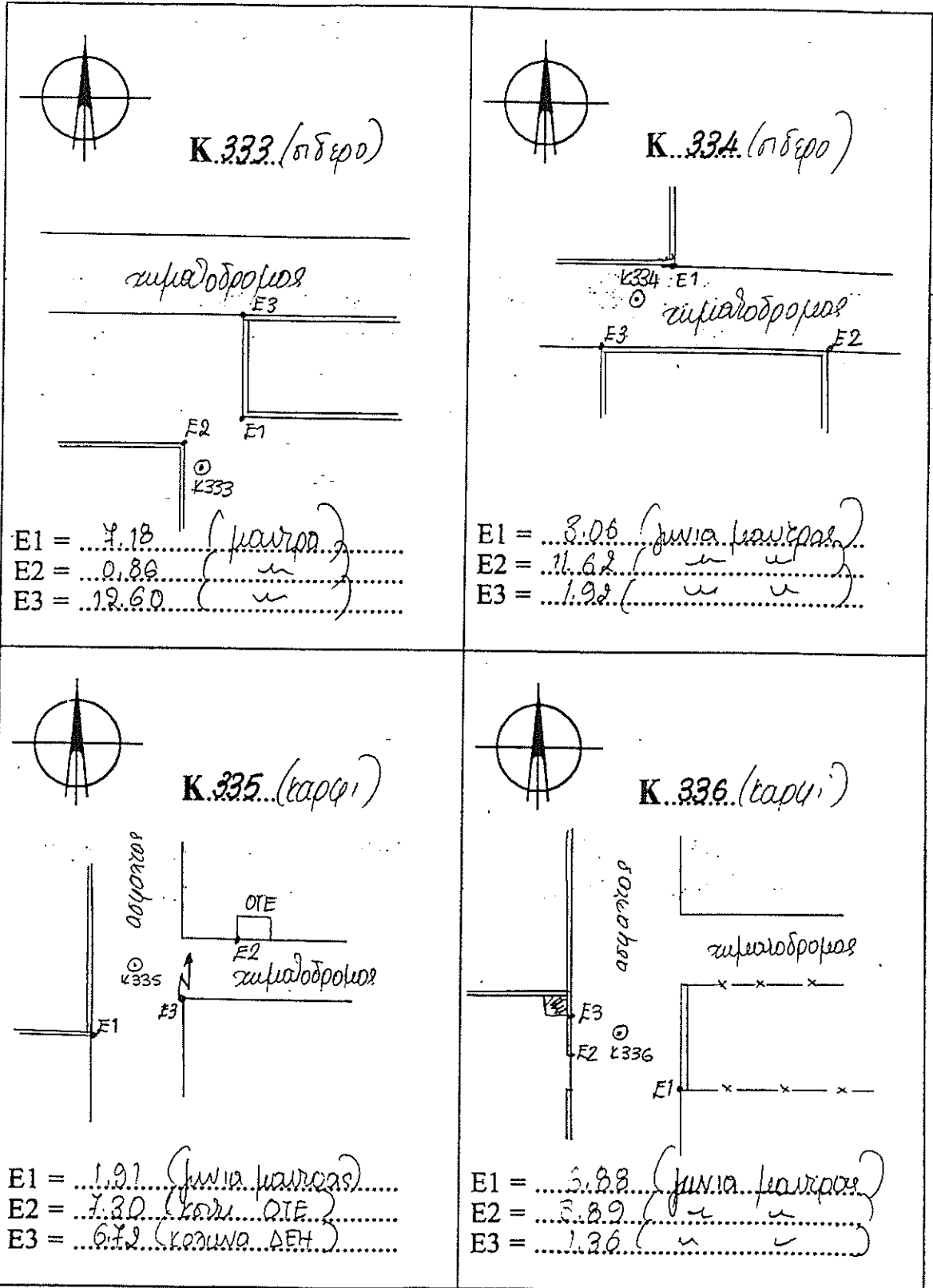

ΕΞΑΣΦΑΛΙΣΕΙΣ ΚΟΡΥΦΩΝ

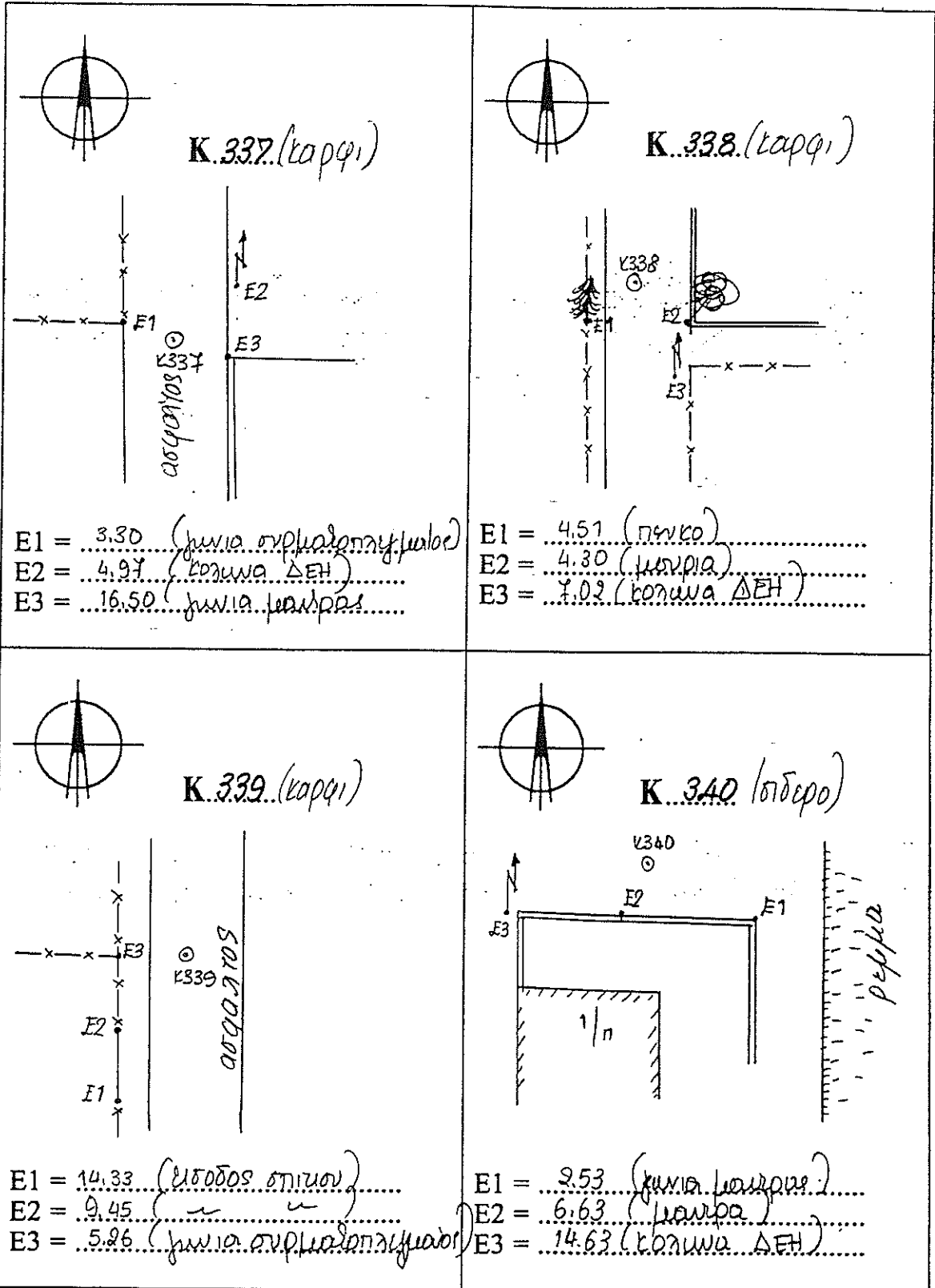

ΕΞΑΣΦΑΛΙΣΕΙΣ ΚΟΡΥΦΩΝ

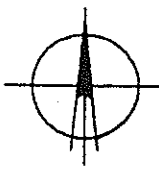
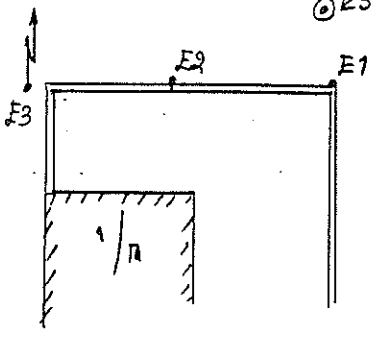
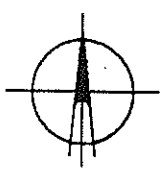
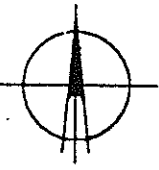
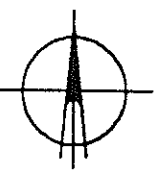
 <p>Κ.341 (σιδερο)</p> <p>⊙ Κ341</p>  <p>Ε1 = 2,35 (γυμνα. μαυρα)</p> <p>Ε2 = 5,15 (καυρα)</p> <p>Ε3 = 12,99 (κολλημα ΔΡΗ)</p>	 <p>Κ.342 (σιδερο)</p> <p>δεν εξασφαλιζεται</p> <p>Ε1 =</p> <p>Ε2 =</p> <p>Ε3 =</p>
 <p>Κ.343 (σιδερο)</p> <p>δεν εξασφαλιζεται</p> <p>Ε1 =</p> <p>Ε2 =</p> <p>Ε3 =</p>	 <p>Κ.344</p> <p>Ε1 =</p> <p>Ε2 =</p> <p>Ε3 =</p>

ΕΞΑΣΦΑΛΙΣΕΙΣ ΚΟΡΥΦΩΝ

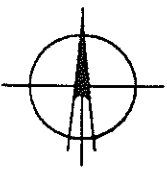
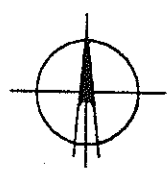
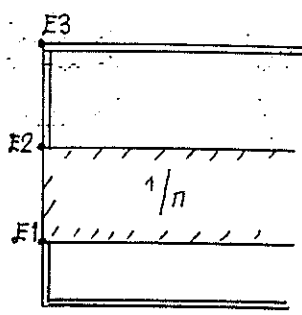
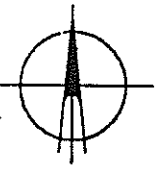
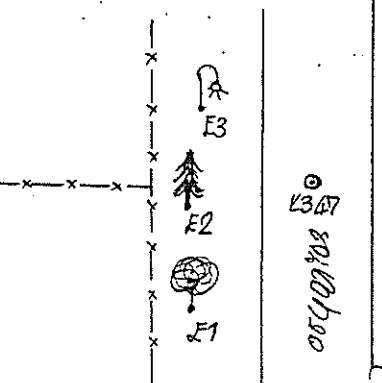
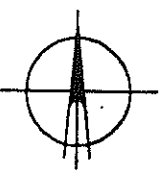
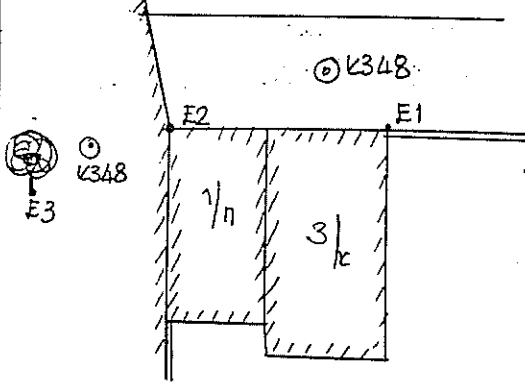
 <p>K.345</p> <p>E1 = E2 = E3 =</p>	 <p>K.346 (σιδερο)</p>  <p>⊙ K346</p> <p>E1 = 19.85 (γωνια σπιτιου) E2 = 10.17 (.....) E3 = 7.97 (.....)</p>
 <p>K.347 (καρφι)</p>  <p>E1 = 18.55 (επιτομιας) E2 = 7.70 (δενδρο) E3 = 10.72 (Φωτιστικο)</p>	 <p>K.348 (σιδερο)</p>  <p>⊙ K348</p> <p>E1 = 9.55 (γωνια σπιτιου) E2 = 10.40 (.....) E3 = 14.85 (δενδρο)</p>

ΕΞΑΣΦΑΛΙΣΕΙΣ ΚΟΡΥΦΩΝ

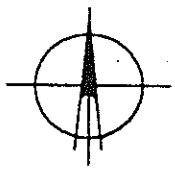
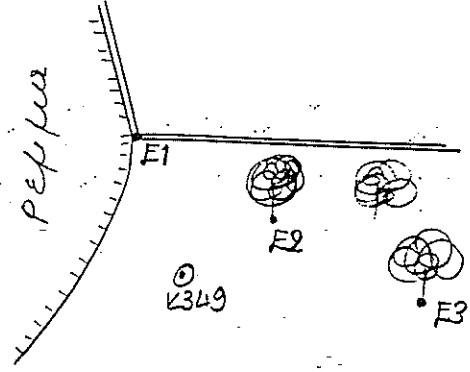
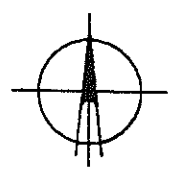
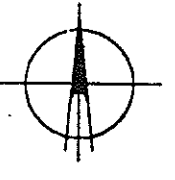
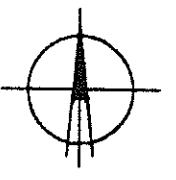
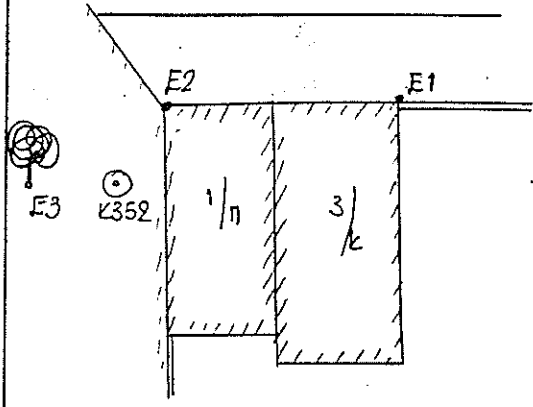
 <p>Κ.349 (σιδερο)</p>  <p>E1 = 10.98 (μνία γοταν ρεφφιας) E2 = 10.60 (μνία) E3 = 10.25 (μ)</p>	 <p>Κ.350 (σιδερο)</p> <p>δεν εργαζομαι φελα</p> <p>E1 = E2 = E3 =</p>
 <p>Κ.351 (σιδερο)</p> <p>δεν εργαζομαι φελα</p> <p>E1 = E2 = E3 =</p>	 <p>Κ.352 (σιδερο)</p>  <p>E1 = 16.78 (μνία σπιτων) E2 = 4.01 (μ) E3 = 7.98 (μνκα)</p>

ΕΞΑΣΦΑΛΙΣΕΙΣ ΚΟΡΥΦΩΝ

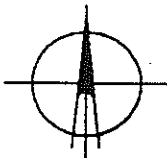
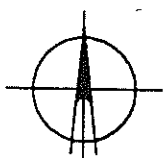
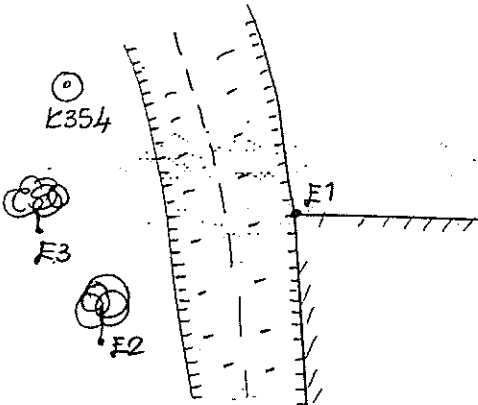
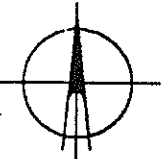
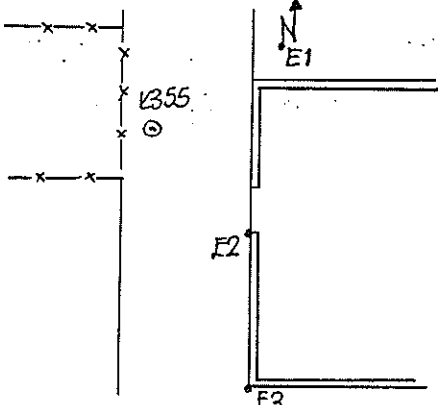
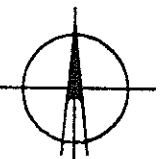
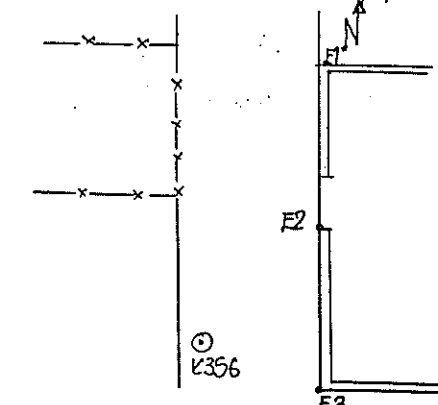
<div style="text-align: center;">  <p>K.353.</p> </div> <p>E1 =</p> <p>E2 =</p> <p>E3 =</p>	<div style="text-align: center;">  <p>K.354 (στρέψ)</p> </div>  <p>E1 = 10.87 (επίπεδο οριζωνιο)</p> <p>E2 = 14.15 (επίπεδο)</p> <p>E3 = 14.14 (επίπεδο)</p>
<div style="text-align: center;">  <p>K.355 (καρφι)</p> </div>  <p>E1 = 11.30 (κοίμη ΔΕΗ)</p> <p>E2 = 9.51 (γωνία υδροδ.σ)</p> <p>E3 = 14.98 (επίπεδο)</p>	<div style="text-align: center;">  <p>K.356 (καρφι)</p> </div>  <p>E1 = 24.50 (κοίμη ΔΕΗ)</p> <p>E2 = 2.93 (γωνία υδροδ.σ)</p> <p>E3 = 6.10 (επίπεδο)</p>

ΕΞΑΣΦΑΛΙΣΕΙΣ ΚΟΡΥΦΩΝ

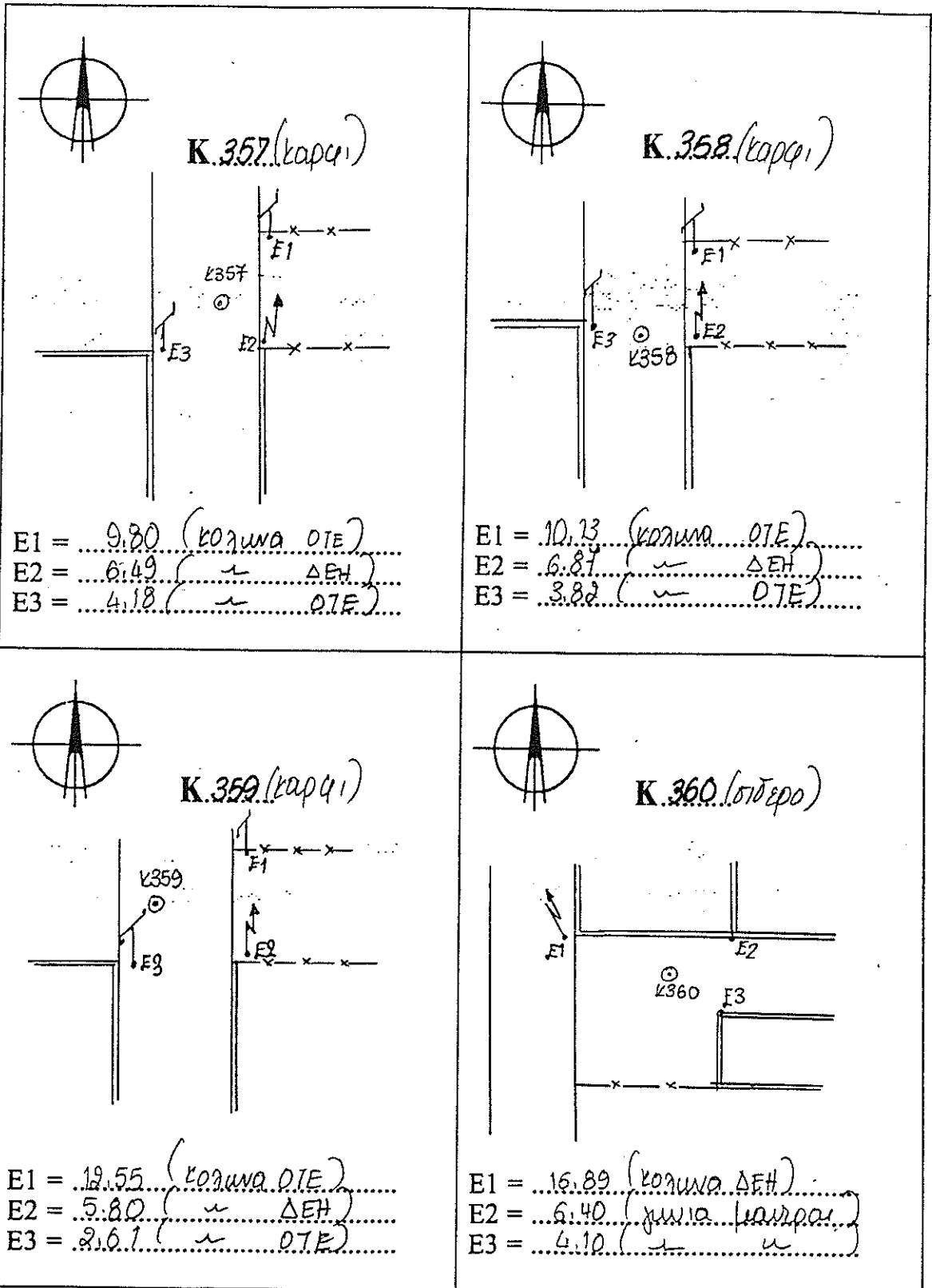

ΕΞΑΣΦΑΛΙΣΕΙΣ ΚΟΡΥΦΩΝ

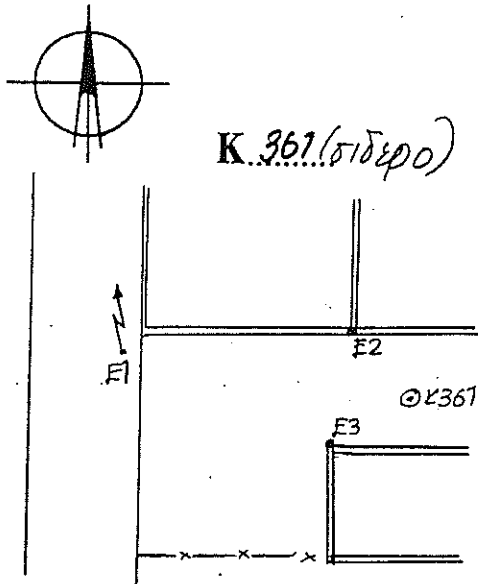
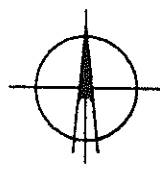
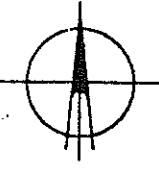
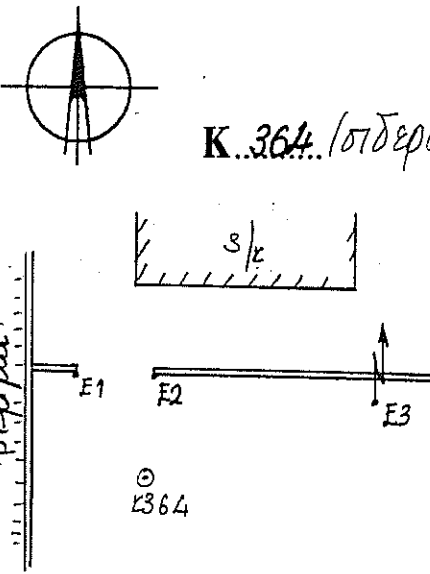
 <p>Κ.361 (σιδερο)</p> <p>Ε1 = 24.14 (κορυφα ΔΕΗ)</p> <p>Ε2 = 4.87 (χιμια κορυφα)</p> <p>Ε3 = 6.25 (.....)</p>	 <p>Κ.362</p> <p>Den zopodetike</p> <p>Ε1 =</p> <p>Ε2 =</p> <p>Ε3 =</p>
 <p>Κ.363 (σιδερο)</p> <p>Den giasagheai</p> <p>Ε1 =</p> <p>Ε2 =</p> <p>Ε3 =</p>	 <p>Κ.364 (σιδερο)</p> <p>Ε1 = 1.75 (μερος οπισω)</p> <p>Ε2 = 1.75 (.....)</p> <p>Ε3 = 15.86 (κορυφα ΔΕΗ)</p>

ΕΞΑΣΦΑΛΙΣΕΙΣ ΚΟΡΥΦΩΝ

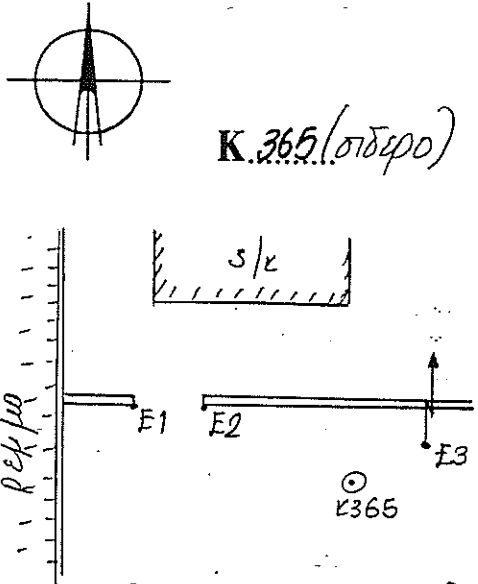
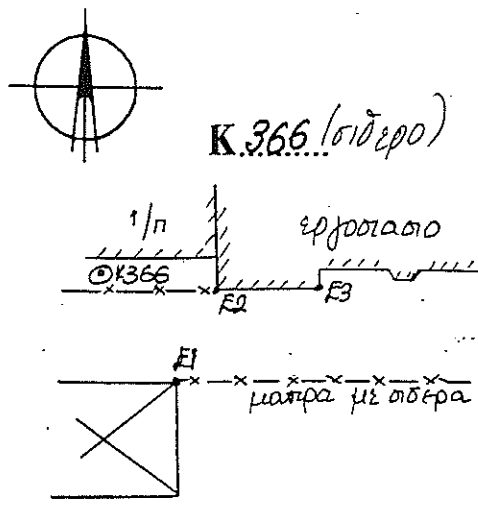
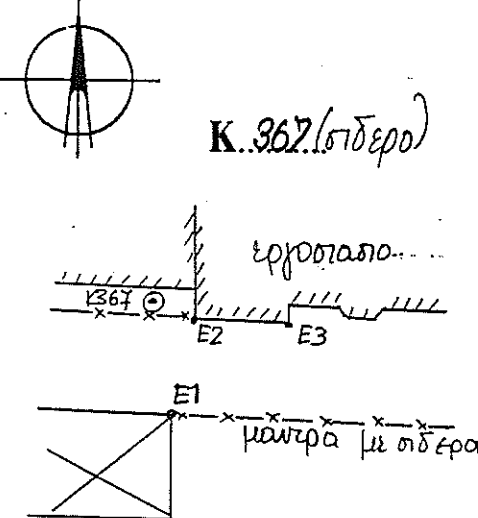
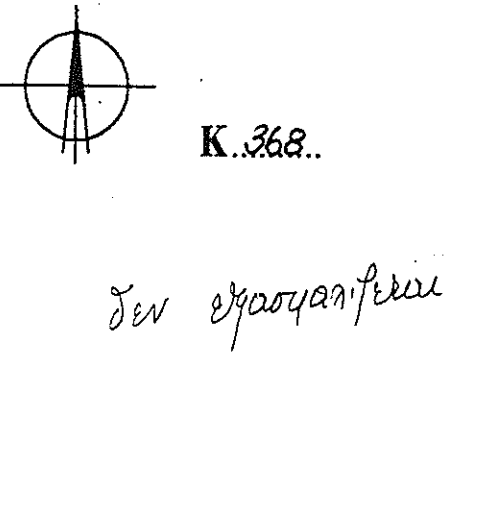
 <p>K.365 (σίδηρο)</p> <p>E1 = 0.79 (μίσκος σπηλιών) E2 = 7.69 E3 = 7.93 (κολλητά ΔΕΗ)</p>	 <p>K.366 (σίδηρο)</p> <p>E1 = 4.21 (για μικρά) E2 = 2.18 (για εργοστάσιον) E3 = 3.09</p>
 <p>K.367 (σίδηρο)</p> <p>E1 = 1.01 (για μικρά) E2 = 1.66 (εργοστασιών) E3 = 6.40</p>	 <p>K.368..</p> <p>Δεν ελασματοφύκει</p> <p>E1 = E2 = E3 =</p>

ΕΞΑΣΦΑΛΙΣΕΙΣ ΚΟΡΥΦΩΝ

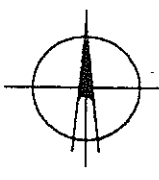
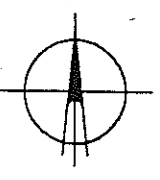
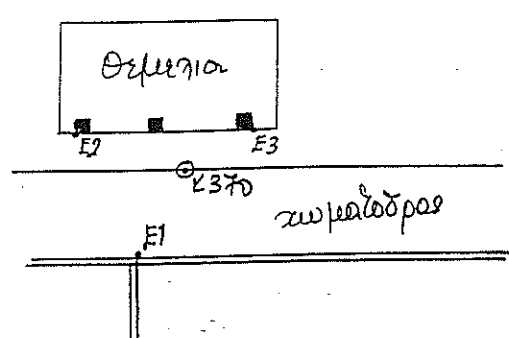
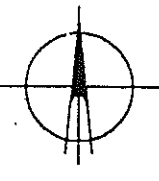
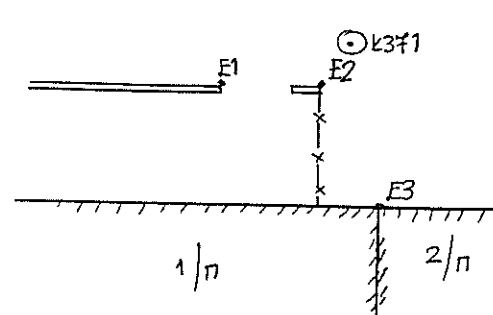
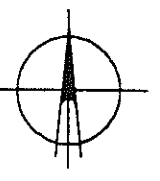
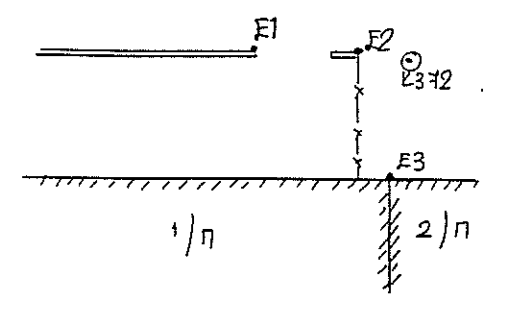
<div style="text-align: center;">  <p>Κ.369 (σιδερο)</p> </div> <p style="text-align: center; font-size: 1.2em;">δεν εξασφαλίζεται</p> <p>E1 =</p> <p>E2 =</p> <p>E3 =</p>	<div style="text-align: center;">  <p>Κ.370 (σιδερο)</p> </div> <div style="text-align: center;">  </div> <p>E1 = 12.66 (για μαυρα)</p> <p>E2 = 12.78 (παδαζακι)</p> <p>E3 = 2.13 ()</p>
<div style="text-align: center;">  <p>Κ.371 (σιδερο)</p> </div> <div style="text-align: center;">  </div> <p>E1 = 11.88 (για μαυρα)</p> <p>E2 = 6.96 ()</p> <p>E3 = 16.49 () σπιτιον</p>	<div style="text-align: center;">  <p>Κ.372 (σιδερο)</p> </div> <div style="text-align: center;">  </div> <p>E1 = 11.62 (για μαυρα)</p> <p>E2 = 6.50 ()</p> <p>E3 = 15.98 () σπιτιον</p>

ΕΞΑΣΦΑΛΙΣΕΙΣ ΚΟΡΥΦΩΝ

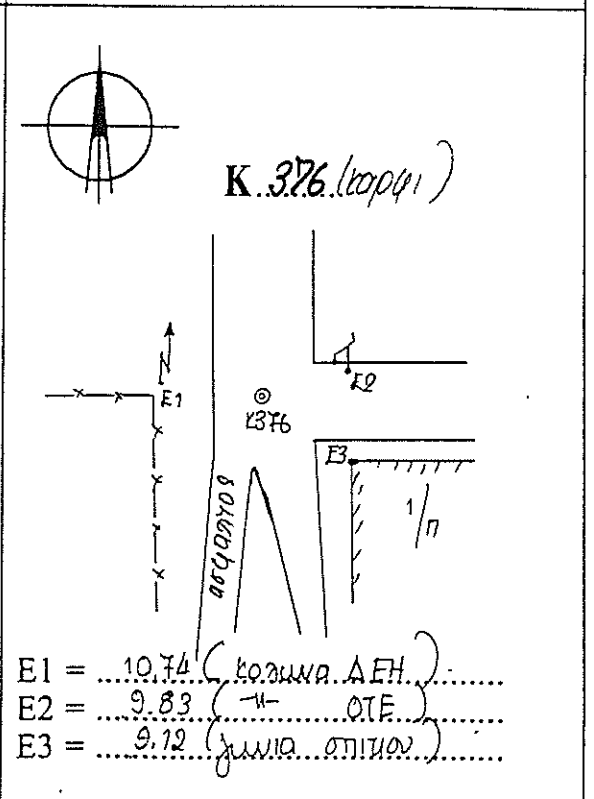
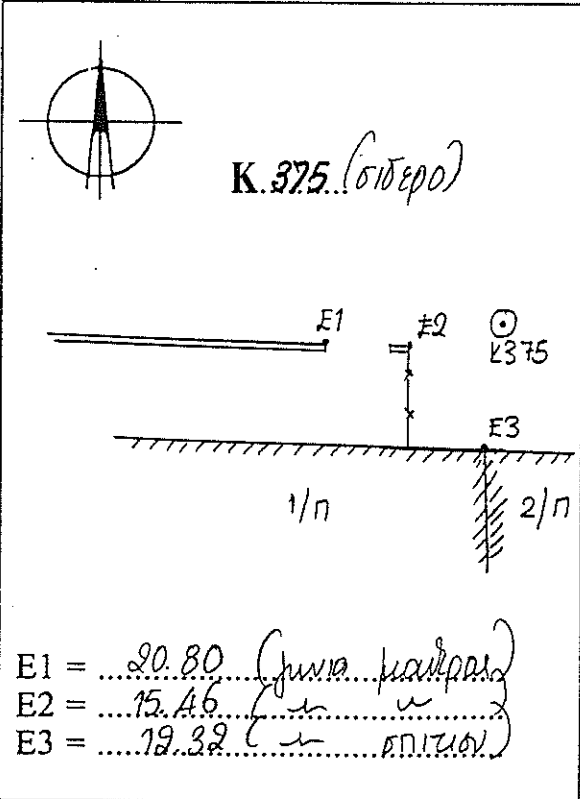
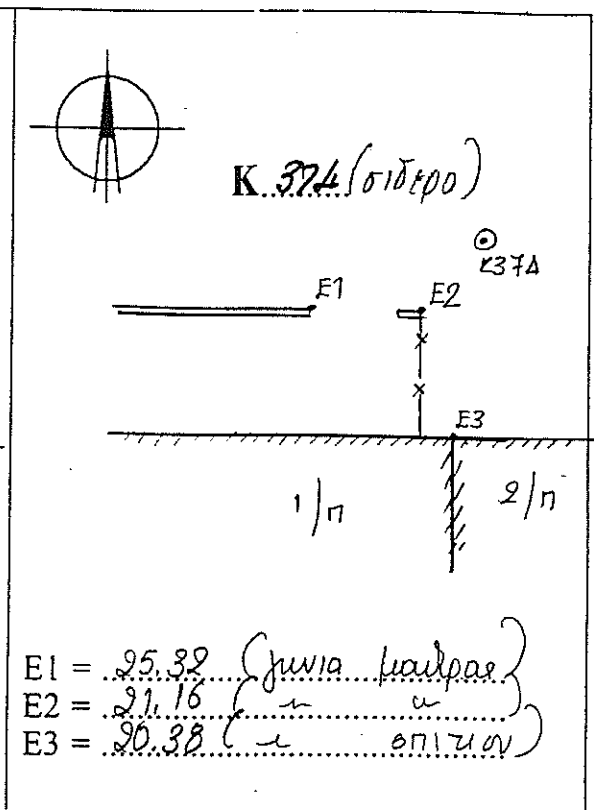
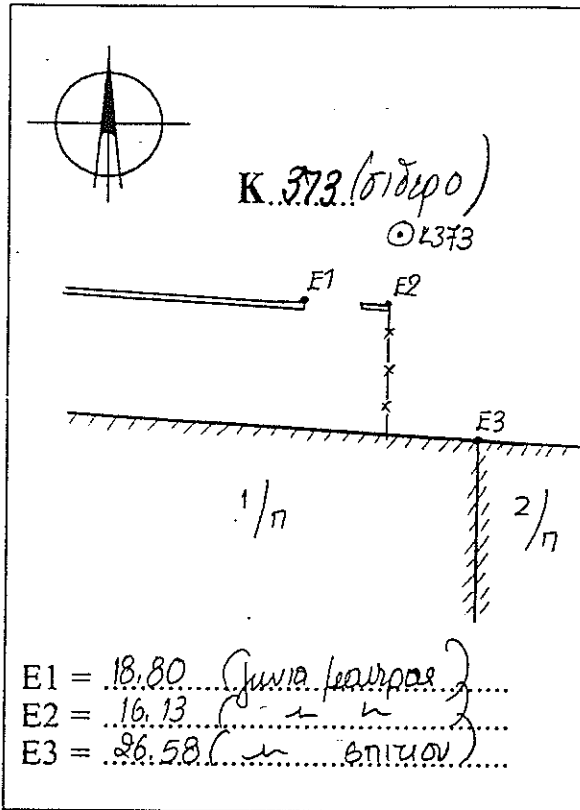

ΕΞΑΣΦΑΛΙΣΕΙΣ ΚΟΡΥΦΩΝ

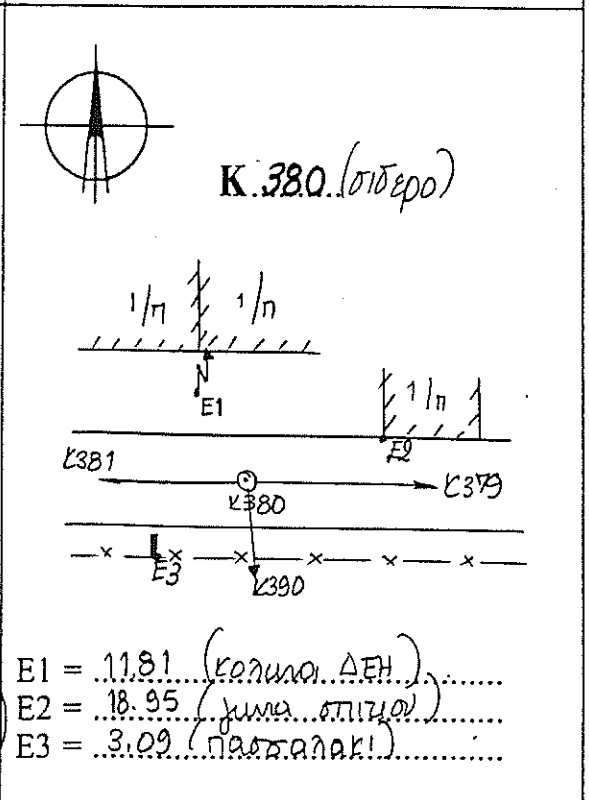
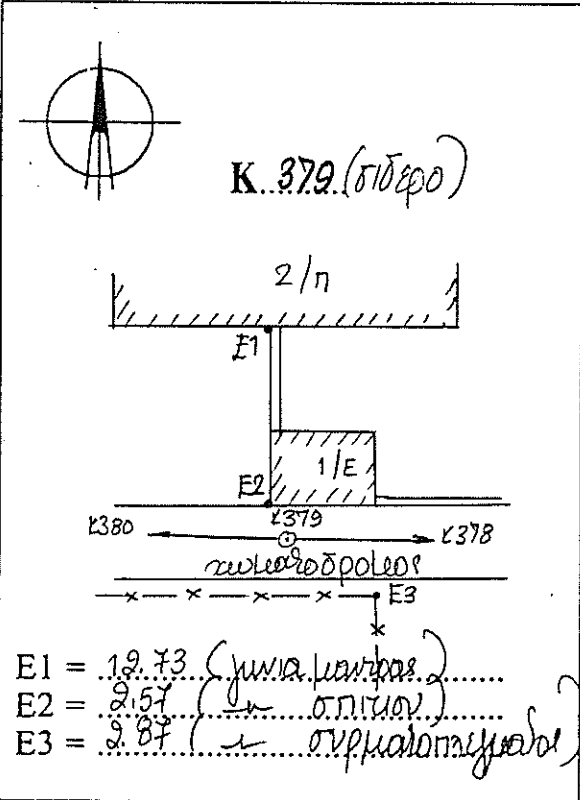
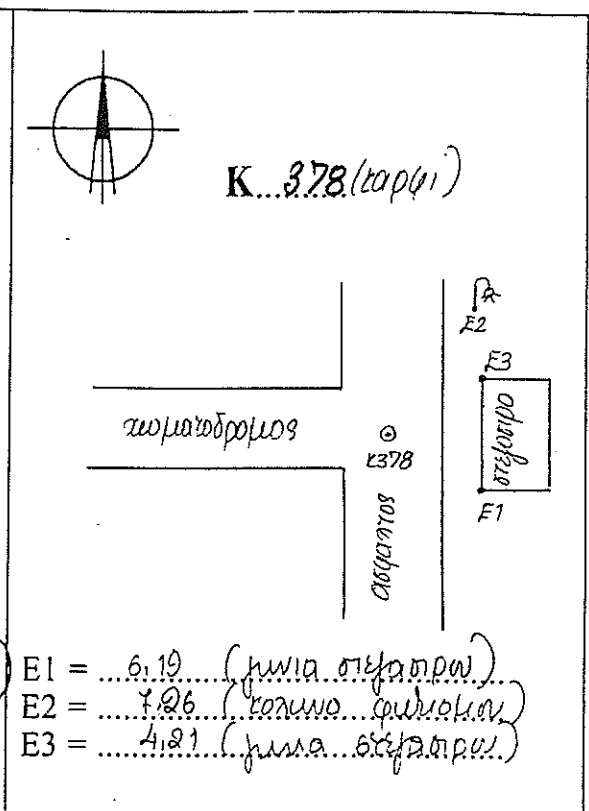
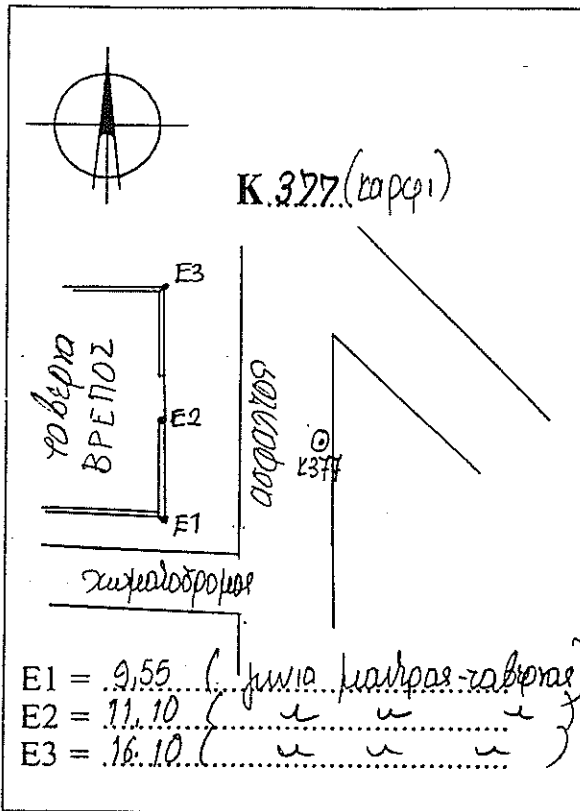

ΕΞΑΣΦΑΛΙΣΕΙΣ ΚΟΡΥΦΩΝ

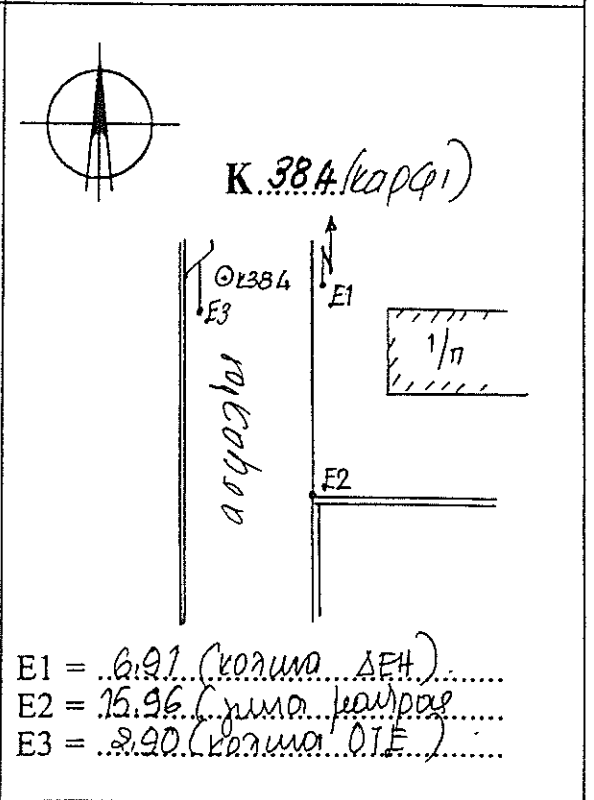
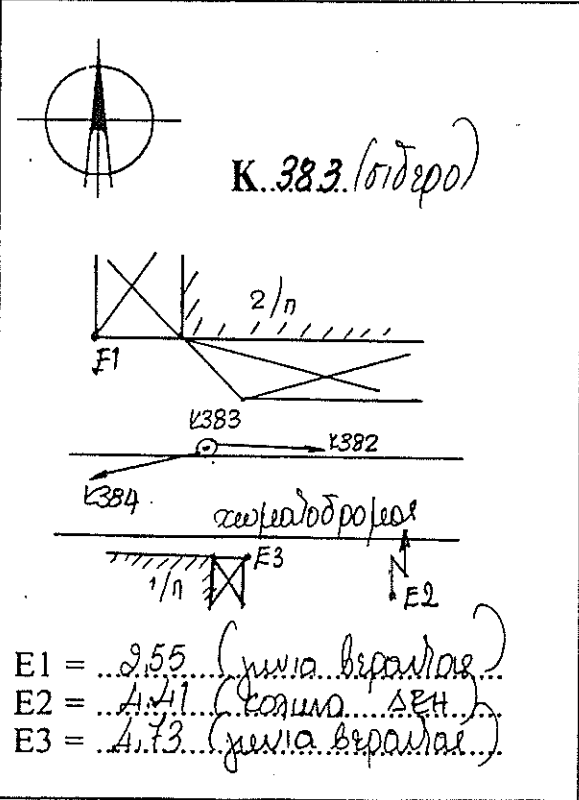
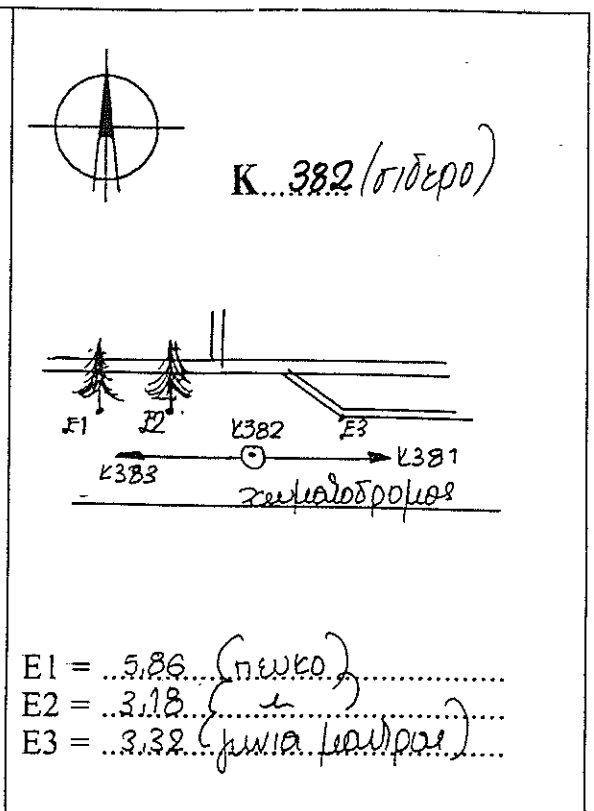
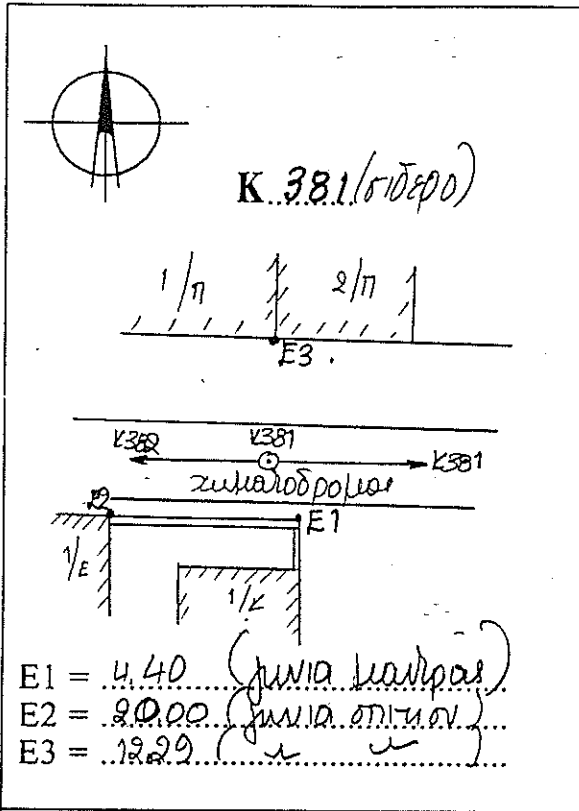

ΕΞΑΣΦΑΛΙΣΕΙΣ ΚΟΡΥΦΩΝ

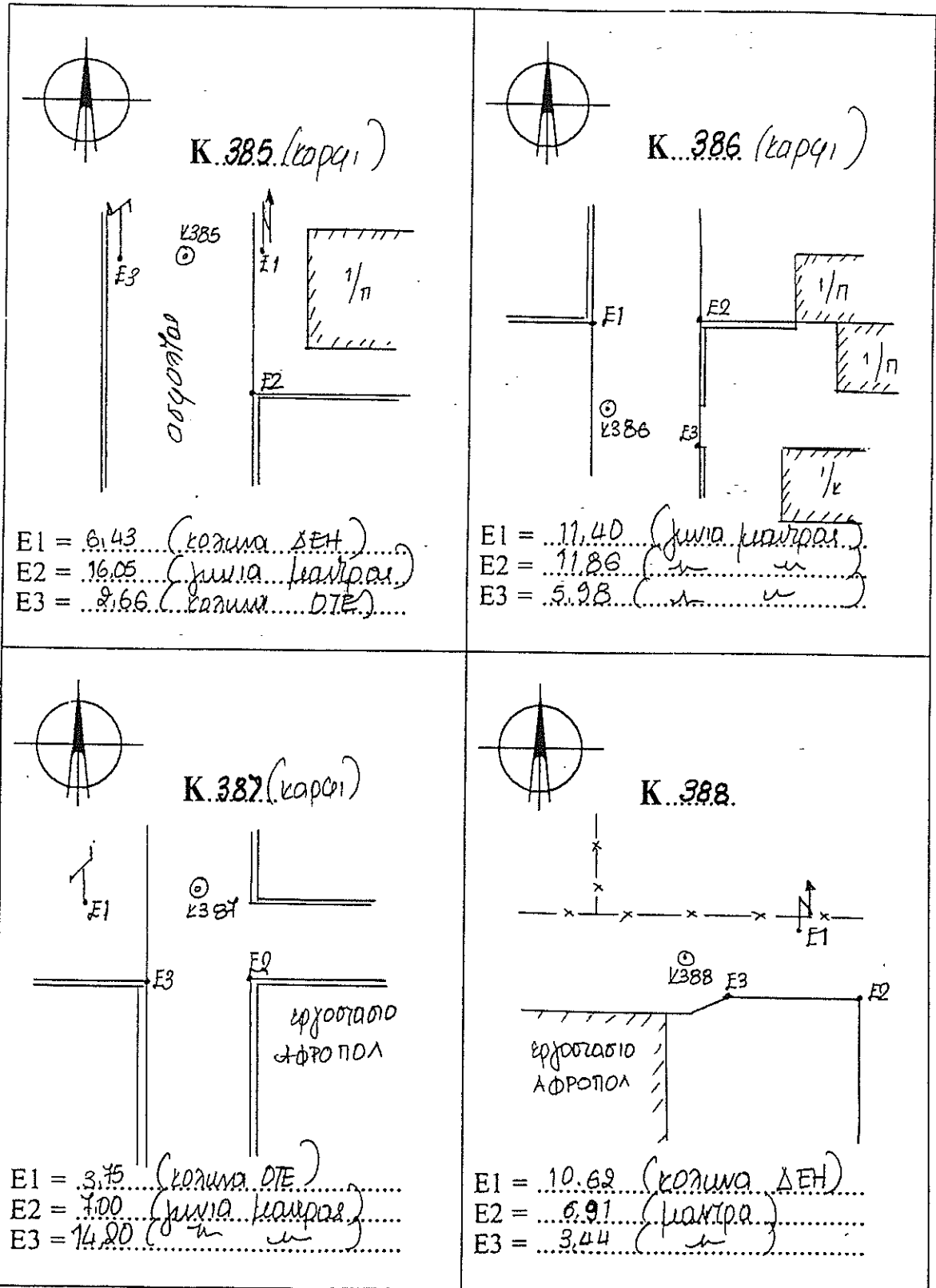

ΕΞΑΣΦΑΛΙΣΕΙΣ ΚΟΡΥΦΩΝ

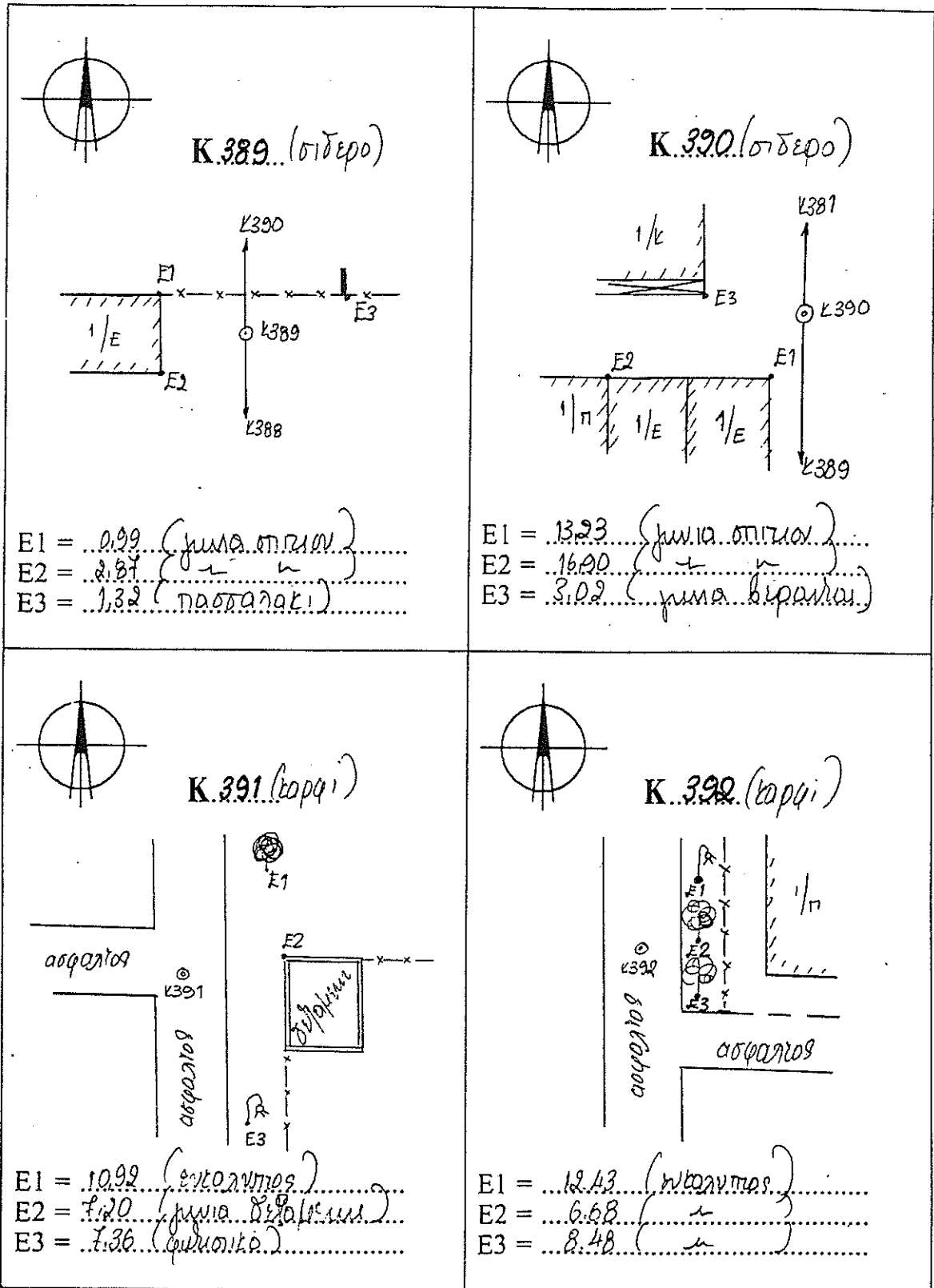

ΕΞΑΣΦΑΛΙΣΕΙΣ ΚΟΡΥΦΩΝ

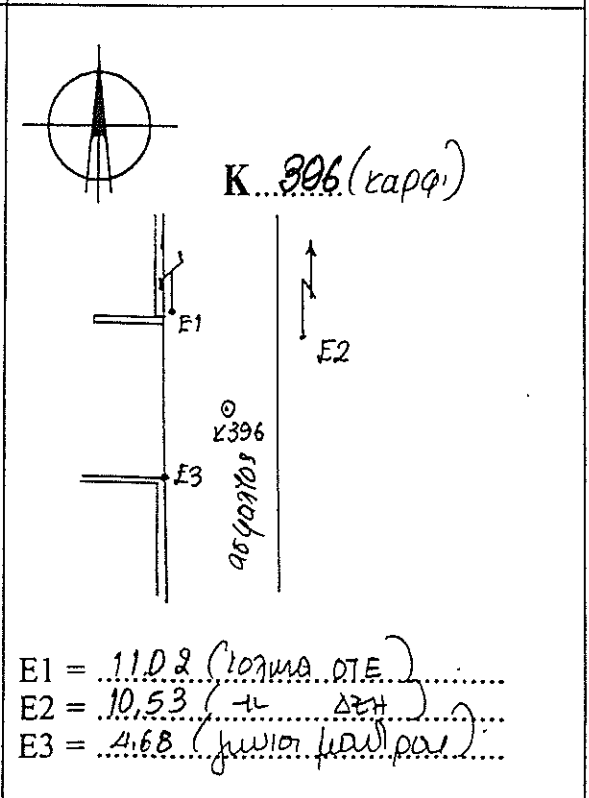
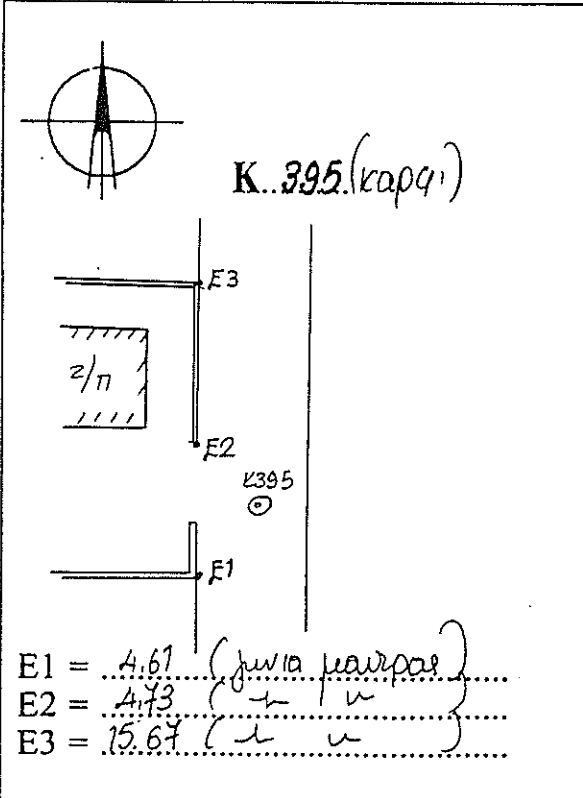
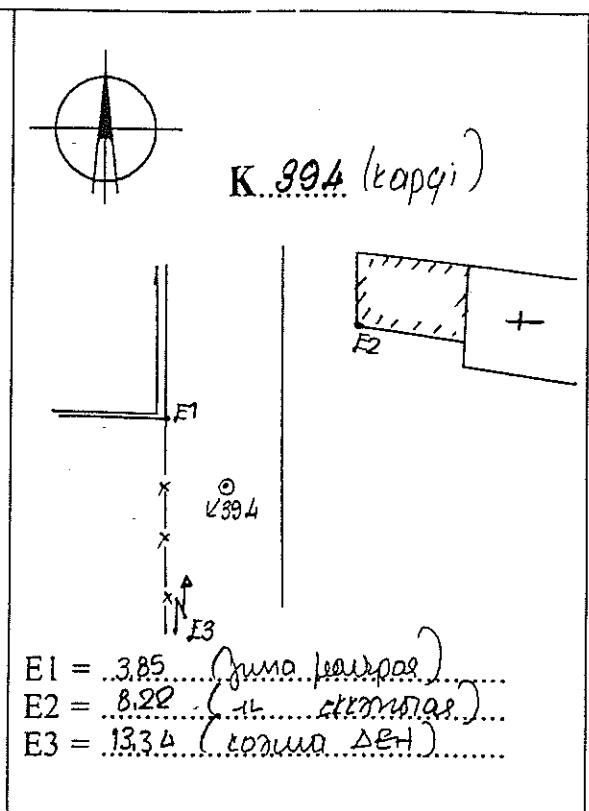
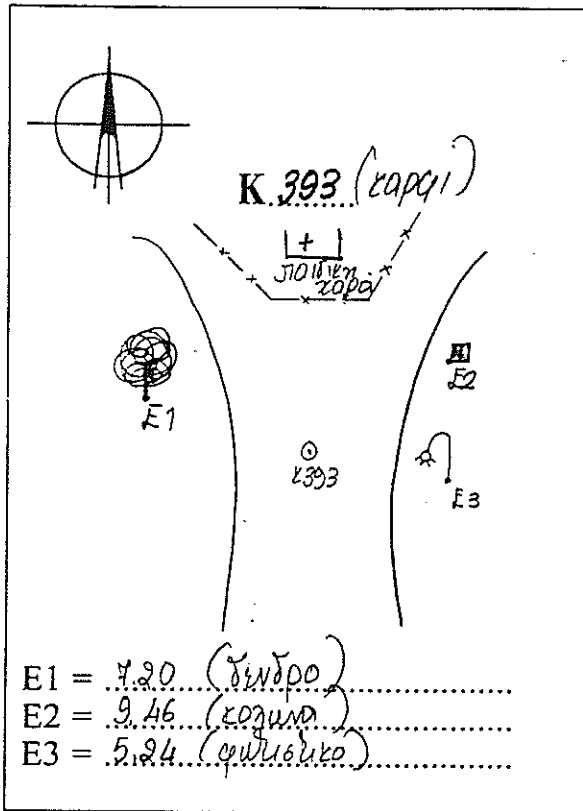

ΕΞΑΣΦΑΛΙΣΕΙΣ ΚΟΡΥΦΩΝ

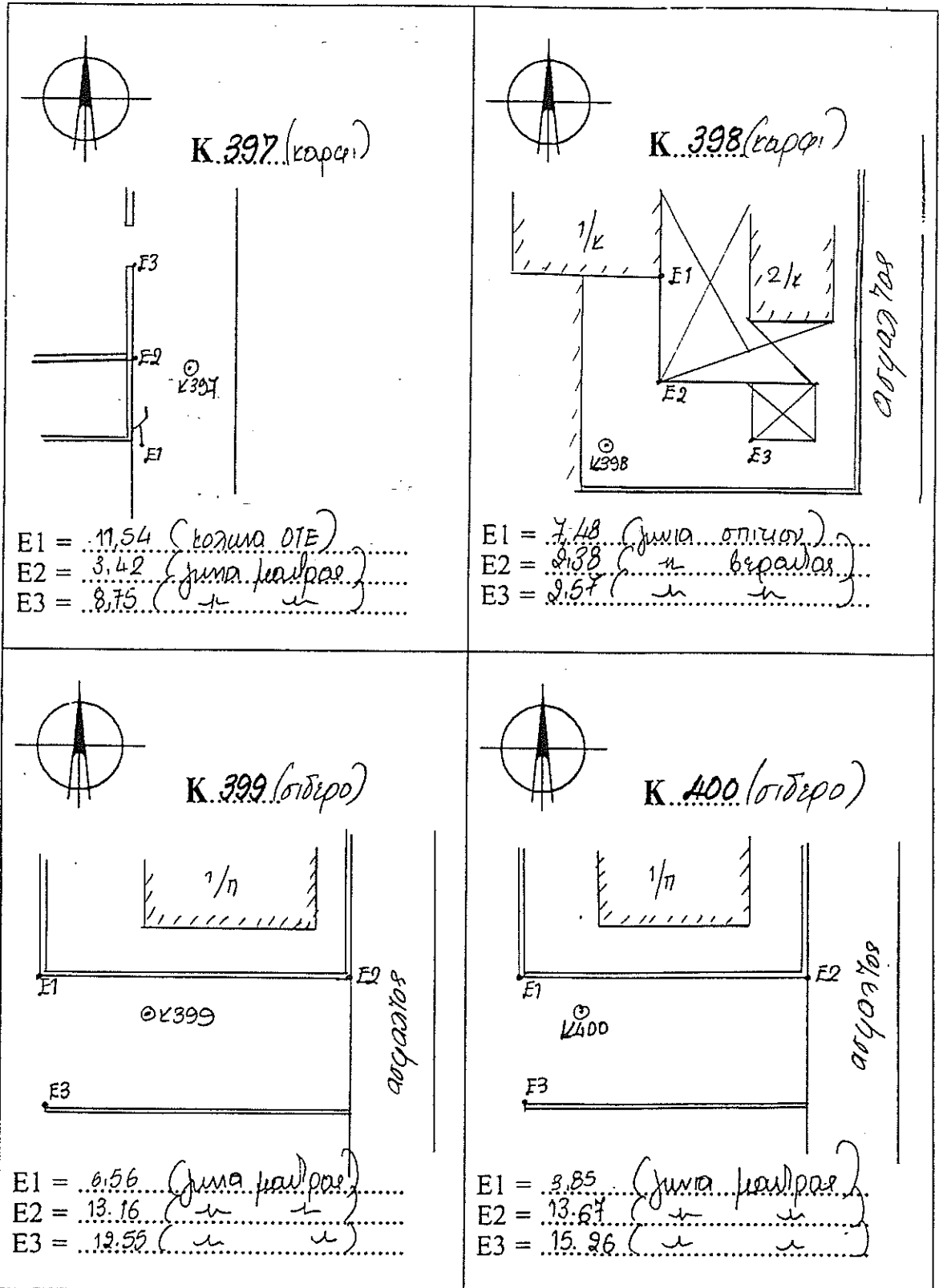

ΕΞΑΣΦΑΛΙΣΕΙΣ ΚΟΡΥΦΩΝ

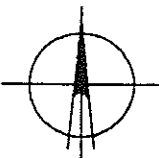
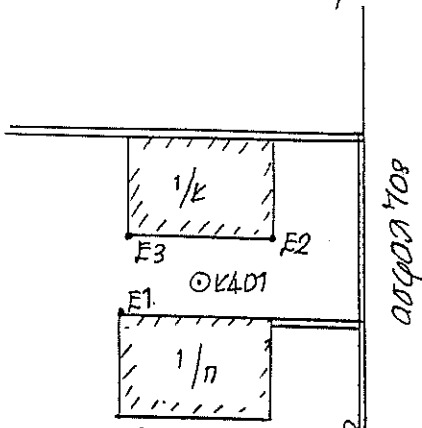
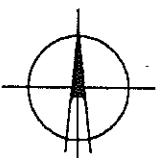
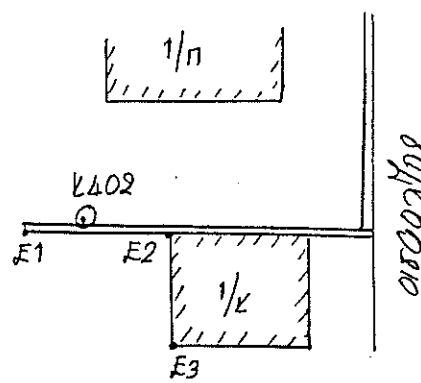
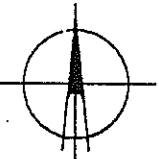
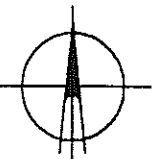
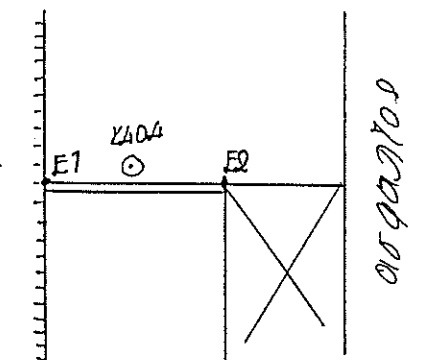
<div style="text-align: center;">  <p>Κ. 401 (σιδερο)</p> </div>  <p style="text-align: right; margin-right: 50px;">ασφαλιστος</p> <p>E1 = 2.98 (για σπιτιου)</p> <p>E2 = 4.66 (" ")</p> <p>E3 = 5.55 (" ")</p>	<div style="text-align: center;">  <p>Κ. 402 (σιδερο)</p> </div>  <p style="text-align: right; margin-right: 50px;">ασφαλιστος</p> <p>E1 = 1.43 (για μαυρα)</p> <p>E2 = 4.32 (" σπιτιου)</p> <p>E3 = 7.53 (" ")</p>
<div style="text-align: center;">  <p>Κ. 403</p> </div> <p style="text-align: center; font-size: 1.2em;">Δεν εξασφαλιζαι</p> <p>E1 =</p> <p>E2 =</p> <p>E3 =</p>	<div style="text-align: center;">  <p>Κ. 404</p> </div>  <p style="text-align: right; margin-right: 50px;">ασφαλιστος</p> <p style="text-align: left; margin-left: 50px;">ρευμα</p> <p>E1 = 1.93 (για ρευμα οροφης μαυρα)</p> <p>E2 = 8.83 (" βραχιας)</p> <p>E3 =</p>

ΕΞΑΣΦΑΛΙΣΕΙΣ ΚΟΡΥΦΩΝ

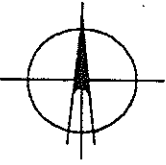
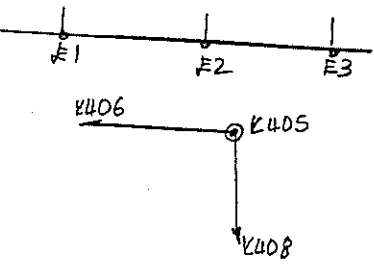
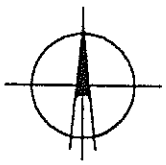
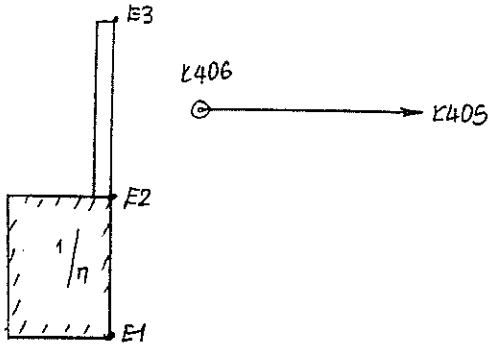
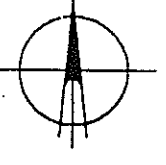
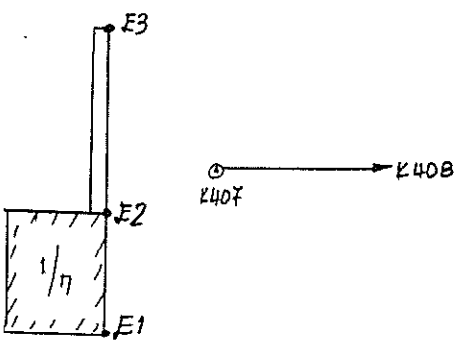
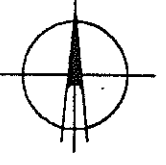
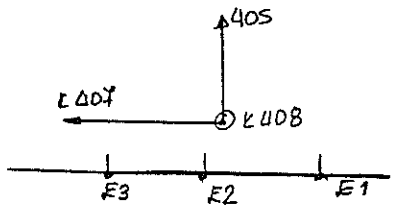
<div style="text-align: center;">  <p>Κ.Α05 (πύργο)</p> </div> <div style="text-align: center;">  </div> <p>E1 = 1.96 (καμμένο)</p> <p>E2 = 0.92 (u)</p> <p>E3 = 2.07 (u)</p>	<div style="text-align: center;">  <p>Κ.Α06</p> </div> <div style="text-align: center;">  </div> <p>E1 = 0.79 (γυμναστική)</p> <p>E2 = 6.21 (u)</p> <p>E3 = 0.82 (u) (καίρα)</p>
<div style="text-align: center;">  <p>Κ.Α07</p> </div> <div style="text-align: center;">  </div> <p>E1 = 0.95 (γυμναστική)</p> <p>E2 = 3.22 (u)</p> <p>E3 = 2.71 (u) (καίρα)</p>	<div style="text-align: center;">  <p>Κ.Α08 (πύργο)</p> </div> <div style="text-align: center;">  </div> <p>E1 = 2.35 (καμμένο)</p> <p>E2 = 1.19 (u)</p> <p>E3 = 1.42 (u)</p>

ΕΞΑΣΦΑΛΙΣΕΙΣ ΚΟΡΥΦΩΝ

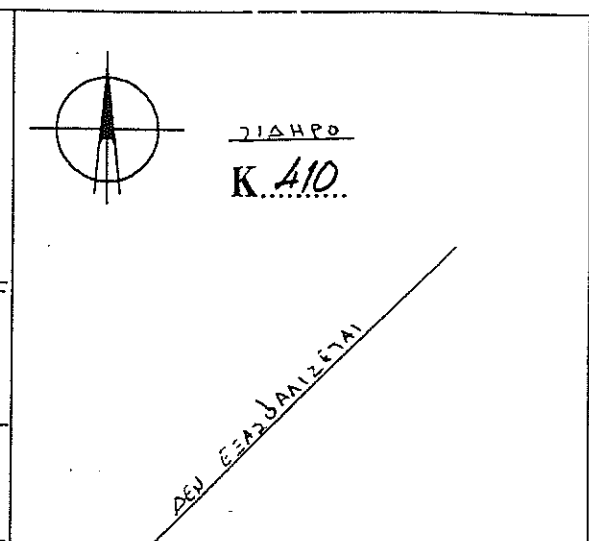
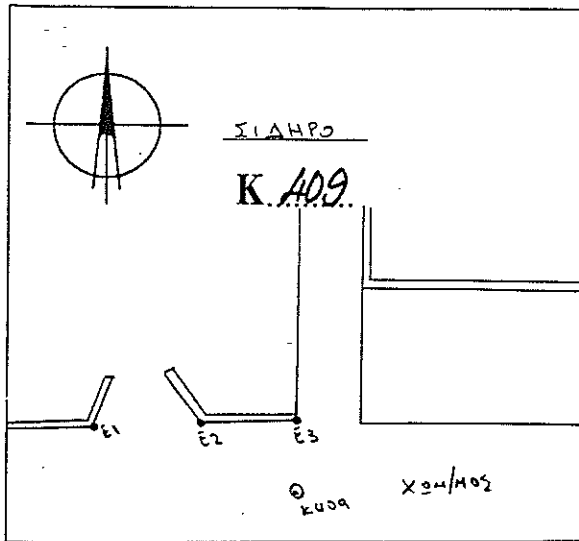

E1 = 8.49 (ΓΩΝΙΑ ΜΑΝΤΡΑΣ)
 E2 = 3.84 (ΓΩΝΙΑ ΜΑΝΤΡΑΣ)
 E3 = 2.80 (ΓΩΝΙΑ ΜΑΝΤΡΑΣ)

E1 =
 E2 =
 E3 =

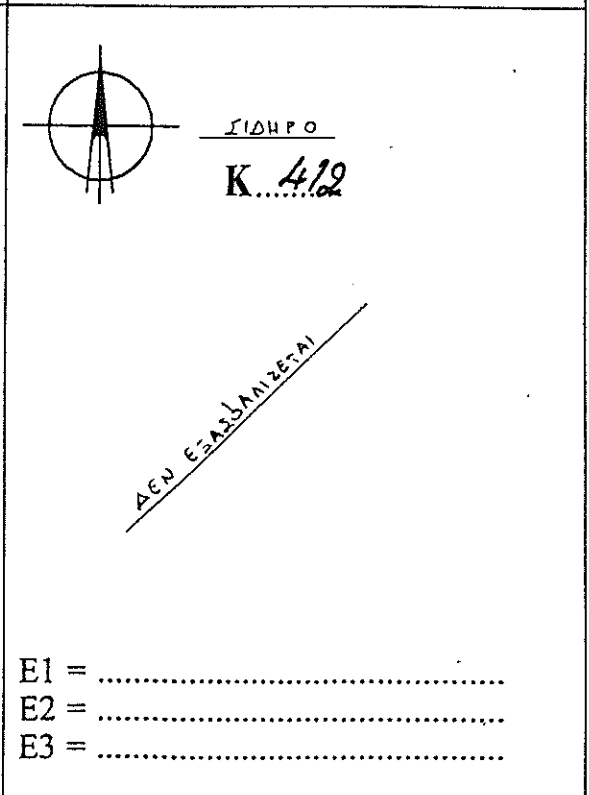
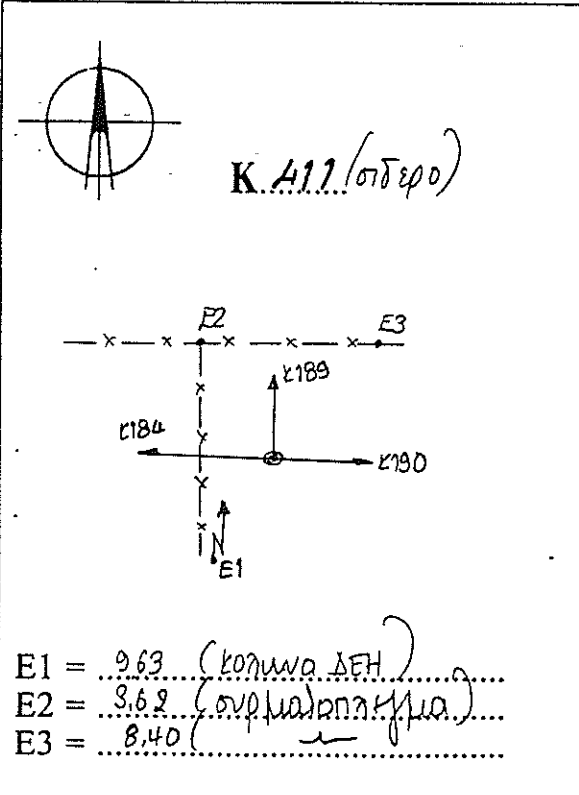

E1 = 9.63 (κοίλω ΔΕΗ)
 E2 = 3.62 (συρματόπληξη)
 E3 = 8.40

E1 =
 E2 =
 E3 =

ΕΞΑΣΦΑΛΙΣΕΙΣ ΚΟΡΥΦΩΝ

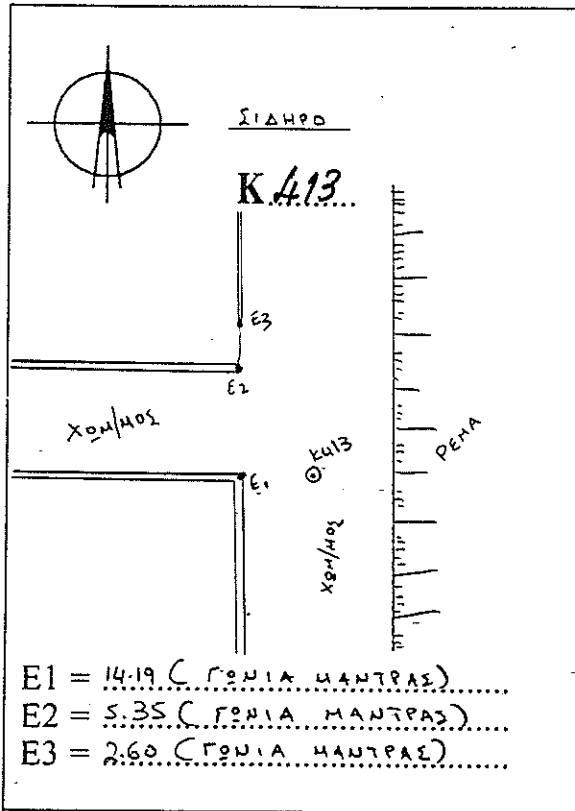

ΣΙΑΜΡΟ
K.413

ΧΩΜ/ΜΟΣ

Θ.Κ.413

ΡΕΜΑ

E1 = 14.19 (ΓΩΝΙΑ ΜΑΝΤΡΑΣ)
E2 = 5.35 (ΓΩΝΙΑ ΜΑΝΤΡΑΣ)
E3 = 2.60 (ΓΩΝΙΑ ΜΑΝΤΡΑΣ)

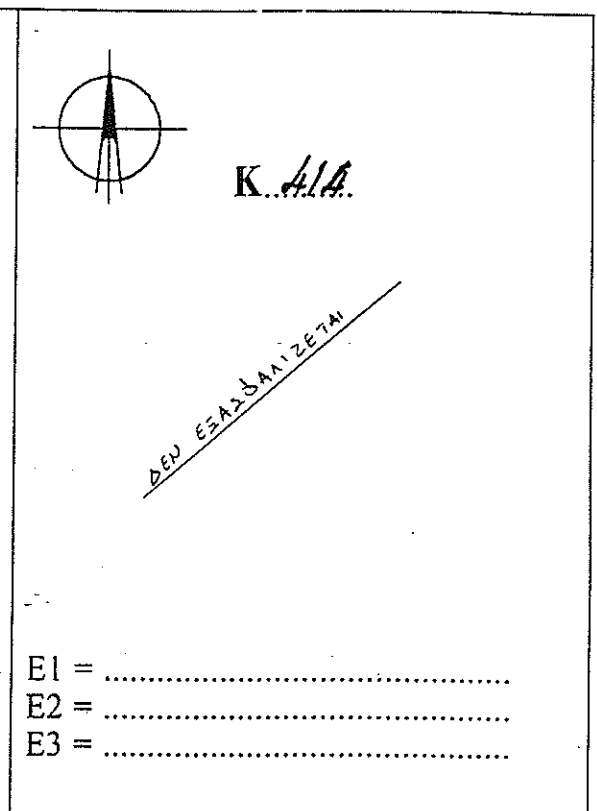

K.414

ΔΕΥ ΕΞΑΣΦΑΛΙΖΕΤΑΙ

E1 =
E2 =
E3 =

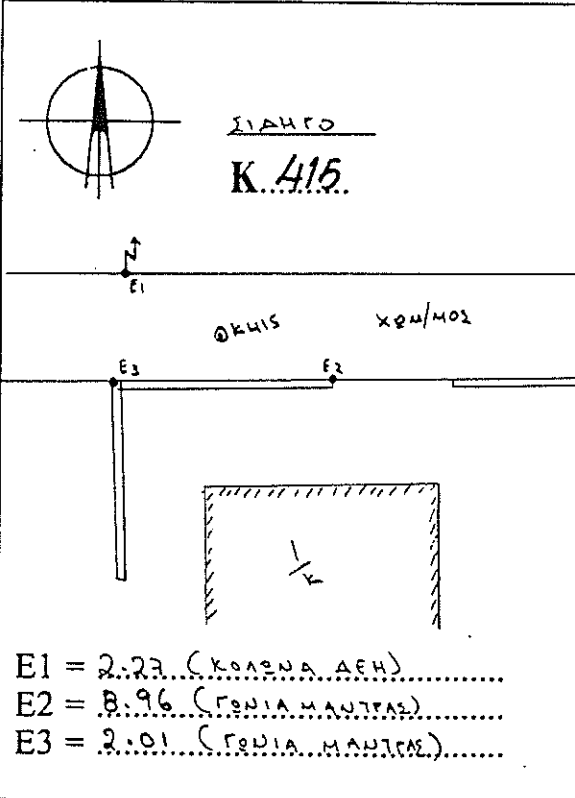

ΣΙΑΜΡΟ
K.415

ΧΩΜ/ΜΟΣ

1/4

E1 = 2.23 (ΚΟΛΩΝΑ ΑΕΗ)
E2 = 8.96 (ΓΩΝΙΑ ΜΑΝΤΡΑΣ)
E3 = 2.01 (ΓΩΝΙΑ ΜΑΝΤΡΑΣ)

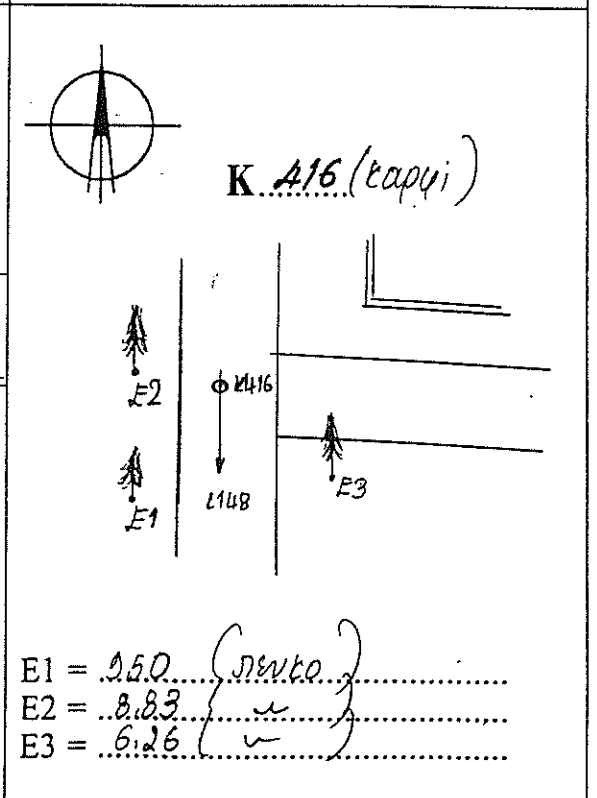

K.416 (καρφι)

E1 = 2.50 (πεντο)
E2 = 8.83
E3 = 6.26

ΕΞΑΣΦΑΛΙΣΕΙΣ ΚΟΡΥΦΩΝ

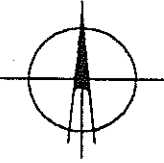
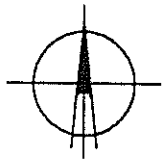
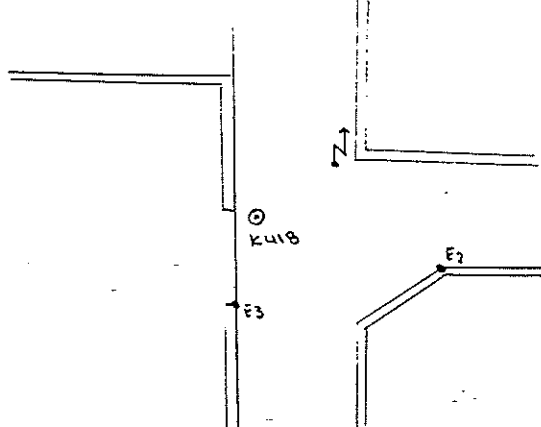
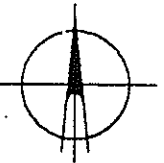
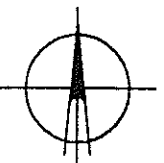
 <p>ΣΙΔΗΡΟ K. 417</p> <p>ΔΕΥ ΕΞΑΣΦΑΛΙΖΕΤΑΙ</p> <p>E1 = E2 = E3 =</p>	 <p>ΚΑΡΔΙ K. 418</p>  <p>E1 = 4.02 (ΚΟΛΩΝΑ ΔΕΗ) E2 = 3.70 (ΓΩΝΙΑ ΜΑΝΤΡΑΣ) E3 = 5.73 (ΓΩΝΙΑ ΜΑΝΤΡΑΣ)</p>
 <p>K. 419</p> <p>E1 = E2 = E3 =</p>	 <p>K. 420</p> <p>E1 = E2 = E3 =</p>